

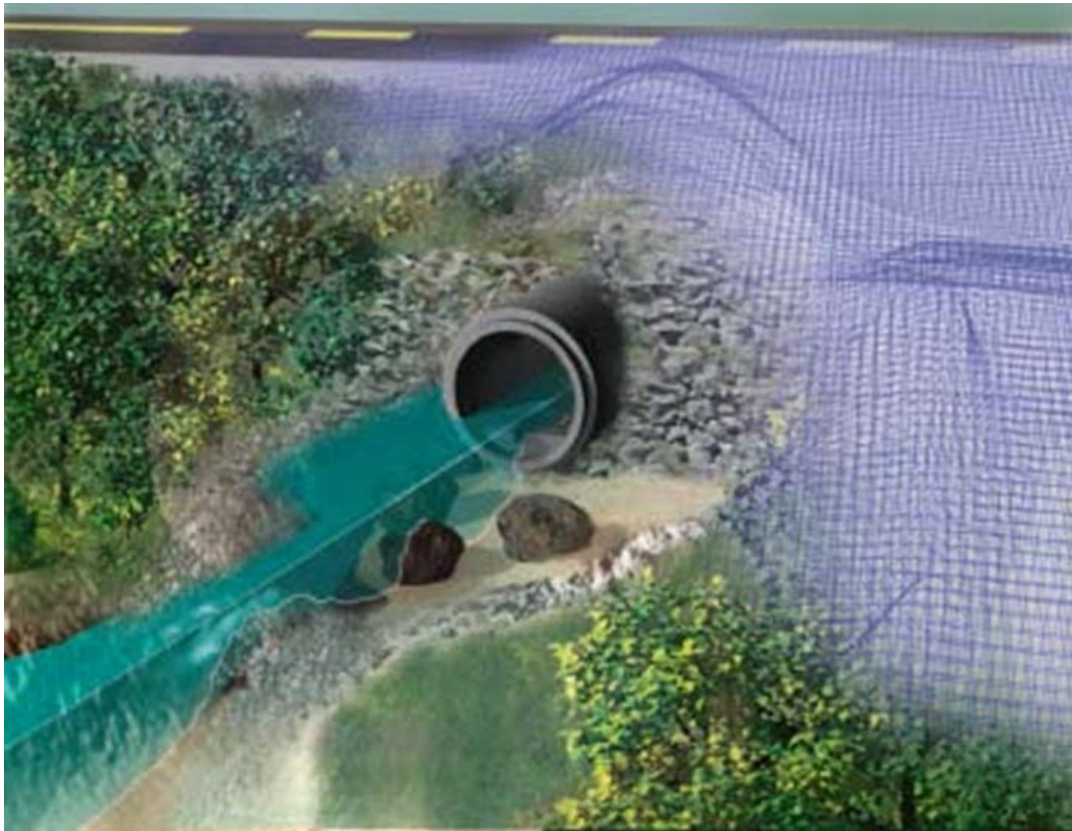

Fisheries and Oceans Pêches et Océans
Canada Canada

Guidelines for the design of fish passage for culverts in Nova Scotia

**Fisheries Protection Program, Maritimes Region
February 2015**



Canada 

Document history

Guidelines for the design of fish passage for culverts in Nova Scotia, Fisheries Protection Program, Maritimes Region, February 2015, is a revision of, and replacement for, the following three documents:

Savoie, R. and D. Haché. Fisheries and Oceans Canada. 2002. *Design criteria for fish passage in new or retrofit culverts in the Maritime provinces, Canada*. Gulf Region, iv + 38 pp. ISBN 0-662-66412-4. Catalogue No. Fs23-410/2002.

Fisheries and Oceans Canada. 1998. (April 1) *Guidelines for the protection of fish and fish habitat: The placement of culverts*. Maritimes Region, Final Draft, April 1. 101 pp.

Conrad, V. and H. Jansen. Fisheries and Oceans Canada. 1996 (January). *Fish passage and habitat preservation for highway culverts in Eastern Canada*. Maritimes Region, Diadromous Fish Division. DFO Document No. 96-01.

Research and writing by

Henry Caracristi and Colleen Smith
Fisheries and Oceans Canada, Maritimes Region
Bedford Institute of Oceanography
P.O. Box 1006, Dartmouth, N.S. B2Y 4A2

Proper citation

Fisheries and Oceans Canada. 2015. *Guidelines for the design of fish passage for culverts in Nova Scotia*. Fisheries Protection Program, Maritimes Region, 95 pp.

DISCLAIMER

The content of this document may be updated periodically to incorporate new information. It is incumbent upon the reader to ensure they are working with the most recent version. Please contact Fisheries and Oceans Canada, Maritimes Region, for more information: ReferralsMaritimes@dfo-mpo.gc.ca.

IMPORTANT NOTICE

Failure to provide for the free passage of fish is an offense under Section 35 of the *Fisheries Act* (Government of Canada, 1985), with penalties for individuals of up to \$2 million and/or imprisonment for up to three years. Under Section 20 of the Fisheries Act (1985), the Minister may request removal, modification or repairs to a structure that does not provide for the free passage of fish. For more information, refer to Appendix A for Federal Legislation.

Ensuring successful fish passage can be complicated. It requires careful design and installation, as well as on-going maintenance. If there is uncertainty a structure adequately provides fish passage, request a Regulatory Review. Submit the information in Appendix B to the nearest Fisheries and Oceans Regional Office. A list of these offices is available at: www.dfo-mpo.gc.ca/pnw-ppe/contact-eng.html.

PURPOSE

The planning, design and installation of new culverts and the maintenance of existing culverts must meet requirements for fish passage under the Canadian *Fisheries Act* (1985). The purpose of this document is to provide procedural and technical information to ensure that engineers and other design professionals properly incorporate fish passage into watercourse crossings.

PREFACE

Why fish passage?

Migration is essential to the biology of many fish species. Complete or partial barriers to a fish's migration route along a watercourse can have serious consequences. Fish can fail to reproduce or they can die as a result of poorly designed passageways that delay their migration or that require them to expend higher than normal energy levels.

Common problems at crossings

Common problems at watercourse crossings are mainly associated with culverts. They include:

- Inadequate water depth to support fish movement
- Excessive water velocities
- Vertical barriers to fish passage (e.g., perching)

Considerations in culvert design

Specific conditions must be met to ensure that fish can pass through a culvert. The primary factors to consider are fish swimming speeds and the hydrologic conditions within the culvert. Design

elements that influence hydrologic conditions within the pipe include culvert length, baffles, energy dissipation pools, water levels and water velocities.

Open-bottom structures

Most fish passage problems can be avoided by using a clear span bridge structure or an open-bottom structure. These structures maintain the natural bed and bank formation of the watercourse. Bridges or properly designed open-bottom structures allow unrestricted movement of the **bedload** by maintaining the natural stream bottom.

Drainage greater than 20 km²

Closed-bottom culverts in drainage areas greater than 20 km² are discouraged because of their extreme complexity. The design of this type of culvert is not addressed in these *Guidelines*.

Table of Contents

DISCLAIMER	2
IMPORTANT NOTICE	3
PURPOSE	4
PREFACE	4
LIST OF FIGURES	6
LIST OF TABLES	6
INTRODUCTION	7
LEGISLATIVE REQUIREMENTS.....	7
TERMINOLOGY	7
APPLICABILITY	8
WATERCOURSE CROSSING ASSESSMENT.....	11
DETERMINING WHERE TO CROSS THE WATERCOURSE	11
SITE ASSESSMENT	12
DESIGNING FISH PASSAGE FOR CULVERTS	16
CULVERTS WITH FISH HABITAT	16
CLOSED BOTTOM CULVERTS	19
CULVERT SIZE.....	22
MINIMUM FLOW DEPTH AND FLOW VELOCITY	23
CULVERT ALIGNMENT	23
INLET AND OUTLET DESIGN	24
CULVERT INSPECTION AND MAINTENANCE	24
NON-BAFFLED CULVERTS.....	25
ENERGY DISSIPATION POOL DESIGN	27
BAFFLED CULVERTS	29
REMEDIATING EXISTING CULVERTS	37
DESIGN CONSIDERATIONS WHEN RETROFITTING EXISTING CULVERTS	39
DESIGN CONSIDERATIONS WHEN INSTALLING A FISH PASSAGE CHUTE	41
REFERENCES CITED.....	42
GLOSSARY	43
ACKNOWLEDGEMENTS.....	48
APPENDIX A: FEDERAL LEGISLATION.....	49
APPENDIX B: REGULATORY REVIEW.....	51
APPENDIX C: PROVINCIAL LEGISLATION	54
APPENDIX D: GUIDELINE APPLICABILITY.....	55
APPENDIX E: NOVA SCOTIA FISH SPECIES REQUIRING FISH PASSAGE	62
APPENDIX F: FISH RESCUE GUIDELINES.....	64
APPENDIX G: CULVERT SITE DESIGN FLOW	67
APPENDIX H: CULVERT DESIGN EXAMPLES.....	75
<i>Example 1</i>	75
<i>Example 2</i>	79
<i>Example 3</i>	82
<i>Example 4</i>	86
APPENDIX I: EXAMPLES OF TYPICAL BAFFLE PLACEMENT.....	90
APPENDIX J: EXAMPLES OF TYPICAL FISH PASSAGE CHUTES FOR ROUND CULVERTS.....	91

LIST OF FIGURES

- Figure 1. Example of site survey data taken at proposed 40 m long culvert. (p. 14)
- Figure 2. Example of a watercourse profile (p. 15)
- Figure 3. Example of a properly installed open-bottom structure (p. 16)
- Figure 4. Example of a poorly installed open-bottom structure (p. 17)
- Figure 5. Example of an embedded culvert (p. 17)
- Figure 6. The installation of a corrugated metal pipe culvert (p. 20)
- Figure 7. Example of a circular concrete culvert with baffles (p. 20)
- Figure 8. Example of a concrete box culvert (p. 21)
- Figure 9. Example of a metal pipe arch culvert (p. 21)
- Figure 10. Culvert installation when fish baffles are not needed (p. 26)
- Figure 11. Energy dissipation pool dimensions (p. 27)
- Figure 12. Energy dissipation pool design drawing for a non-baffled culvert (p. 28)
- Figure 13. Installation of a culvert with baffles (p. 30)
- Figure 14. Energy dissipation pool design drawing for a baffled culvert (p. 31)
- Figure 15. Illustration of a drop between baffles (p. 32)
- Figure 16. Baffle notch sizing for concrete culvert baffle (cross-sectional area) (p. 33)
- Figure 17. Baffle sizing for metal culvert baffle (p. 33)
- Figure 18. Maximum drop between baffles considering Rainbow smelt (p. 35)
- Figure 19. Example of baffle spacing (p. 35)
- Figure 20. Minimum baffle spacing (p. 36)
- Figure 21. Formula to calculate maximum baffle spacing (p. 36)
- Figure 22. Example of a culvert in need of remediation (p. 37)
- Figure 23. Concrete weirs used as control structures in a watercourse (p. 39)
- Figure 24. Control structures in a watercourse (p. 40)
- Figure 25. A chute installation on a culvert (p. 41)
- Figure 26. Culvert with a chute installed (p. 41)
- Figure 27. Typical fish passage chute (p. 41)
- Figure 28. Illustration of general culvert installation terms (p. 43)
- Figure 29. Pool-riffle sequence and erosional and depositional features (p. 46)

LIST OF TABLES

- Table 1. Cross-sectional open areas with and without baffles (p. 22)
- Table 2. Notch sizes derived using the Larimer (2003) formula (p. 34)

INTRODUCTION

The installation of [watercourse](#) crossings may have a significant impact on the survival of many fish species. These *Guidelines* provide the information necessary for the proper design, installation and maintenance of culverts so that these watercourse crossings meet the requirements for fish passage under the *Fisheries Act* (1985).

It is most cost-effective to identify and provide the necessary protection measures for fish and fish habitat early in the planning and design phases of your culvert proposal. These *Guidelines* address fish passage design for new culverts (including replacement culverts) and for the repair of the existing culverts that do not currently meet requirements under the *Fisheries Act*.

Note:

The best solution for fish passage is a bridge or an open-bottom structure. These should be considered first.

Variations in approach

Variations from the solutions provided in this document may be proposed. However, any alternative approach must ensure adequate fish passage. Variations in approach are considered on a case-by-case basis by Fisheries and Oceans Canada (DFO). Please refer to Appendix B: Regulatory Review.

LEGISLATIVE REQUIREMENTS

Federal

In Canada, most bodies of water contain fish or their habitat that are part of, or support, commercial, recreational or Aboriginal fisheries. These fish and their habitat are protected under the *Fisheries Act*. Fish species that are designated as “at risk” may also be protected under the *Species at Risk Act* (2002).

Proponents are responsible for avoiding and mitigating serious harm to fish and [fish habitat](#). Penalties associated with not appropriately protecting fish and fish habitat are outlined on p. 3. If you are unable to completely avoid or [mitigate](#) serious harm to fish, your project will likely require authorization under Subsection 35(2) of the *Fisheries Act*. If the project is not properly authorized, it may contravene the *Fisheries Act*.

Relevant sections of both the *Fisheries Act* and the *Species at Risk Act* are included in Appendix A.

Provincial

In Nova Scotia the watercourse alteration approval process is regulated by the Activities Designation Regulations pursuant to the Nova Scotia *Environment Act* (1995). For information on relevant provincial legislation, please see Appendix C.

TERMINOLOGY

All terms are defined and sometimes illustrated in the Glossary on p. 44. The first instance of all defined terms is included in the body of the text in [blue type](#).

APPLICABILITY

These *Guidelines* (see Appendix D: Guideline Applicability) pertain to the design, installation and maintenance, including retrofitting, of permanent single culverts where the watershed size is no more than 20 km² and the watercourse supports fish that require fish passage.

These *Guidelines* apply to:

- Open-bottom structures that alter the bed and/or banks of the watercourse
- Embedded culverts > 4 000 mm in diameter
- Non-baffled culverts (depending on the watercourse slopes, culvert diameter, and culvert length) where drainage area < 20 km²
- Baffled culverts as fishways for various watercourse slopes (depending on proposed culvert diameter and length) where drainage area < 20 km²
- The repair of existing culverts that currently do not allow for adequate fish passage, by incorporating fish passage chutes or downstream weirs depending on the drop height.

These *Guidelines* do NOT apply to:

- Watershed areas > 20 km²
- Temporary watercourse crossings
- Watercourse slopes that are > 8% slope

- Embedded culverts < 4 000 mm in diameter
- Tidally influenced culverts
- Multiple culverts
- Engineered channels constructed for water control
- Watercourses that do not support fish that require fish passage
- Site-specific fish passage design

Key first questions:

1. Is this a natural watercourse or an engineered channel constructed for water control?
2. Does this watercourse support fish that require fish passage?

Is this a natural watercourse or an engineered channel constructed for water control?

In order to identify a natural watercourse, examine the channel upstream and downstream of the proposed crossing. A natural watercourse can be identified by some of these features:

- the in-stream substrate
- well-defined banks
- the presence of headwaters, such as wetlands or lakes
- the presence of fish

Water may not always be present in watercourses at all times of year. The water level and water flow will fluctuate

naturally depending on the time of year and it will vary from year to year.

Absence of fish

The absence of fish does not indicate that the channel is not a natural watercourse.

Historically diverted watercourses

Watercourses that have been historically diverted into engineered channels are considered natural watercourses and are subject to all applicable legislation.

Engineered channels

Engineered channels such as irrigation or roadside ditches do NOT require fish passage. In fact, engineered channels should not be connected to natural watercourses. It is important to ensure that fish cannot enter engineered channels.

These are not considered watercourses:

- irrigation channels
- agricultural drains
- drainage or roadside ditches (please see note above about historically diverted watercourses)

If your watercourse is an engineered channel constructed for water control, these *Guidelines* do NOT apply to your project.

Does this watercourse support fish that require fish passage?

Most species that require fish passage are those that are involved in a commercial, recreational or Aboriginal fishery. For a list of these fish species found in Nova Scotia waters, please see Appendix E.

It is safe to assume that most watercourses in Nova Scotia contain at least some of the fish species presented in Appendix E and require fish passage.

Does my site require fish passage?

If you determine that your project will incorporate fish passage, no further habitat assessment is required. However, in order to determine that the proposed site does not contain fish that require fish passage, you should complete a fish habitat assessment of the crossing site. Only a [qualified person](#) can conduct an assessment of fish and fish habitat. The qualified person needs to conduct a habitat evaluation that would include information about the fish habitat and its features, including substrate classification, water quality parameters and natural barrier identification. For more information refer to the Site Assessment section beginning on p. 12.

If it is determined that fish could be present based on the habitat evaluation then the assessment should include electrofishing approximately 100 m on the upstream and downstream ends of the proposed culvert. The qualified person will need to obtain an electrofishing license from Fisheries and Oceans Canada (see Appendix F). The results will indicate the fish species, relative abundance and age structure (size) of fish frequenting the waters where the crossing is proposed.

If the results of the fish habitat assessment indicate that no fish species that require fish passage are present and/or that the physical habitat cannot support the fish then passage is not required. In this case, use the design and installation for non-baffled culverts on p. 25.

Other criteria at the site that a qualified person may identify as justification for not providing fish passage should be documented and consultation with DFO, Fisheries Protection Program (FPP) should occur before you proceed. (For example, invasive species, natural barriers and pH issues, etc.).

At any time DFO-FPP may request to review materials prepared by a qualified person as part of our monitoring program. This information should be made available upon request.

WATERCOURSE CROSSING ASSESSMENT

A variety of factors, including economic and legislative constraints, drainage area, and watercourse slope affect what type of crossing is appropriate for your project.

Watercourse crossings: Options

1. A watercourse crossing such as a bridge or open-bottom structure that maintains the watercourse bed and banks is the best environmental option. These options allow movement of the bedload in the channel, protect the integrity of the watercourse, and provide unrestricted movement of fish. These types of crossings are not addressed in these *Guidelines*.
2. The second preference is to install a culvert with fish habitat by recreating or mimicking the natural watercourse. This is done by embedding the culvert and then rebuilding the watercourse within the culvert. However, as discussed on p. 17, this option is limited in its application.
3. The third option for watercourse crossings are closed-bottom culverts with or without baffles (determined by watercourse slope). This option is the most complicated to design. It requires careful installation and ongoing maintenance. For a fish to successfully negotiate a closed-bottom culvert crossing, it must enter the culvert barrel, traverse the length of the barrel, exit the barrel at the upstream end, and proceed to the first resting area.

DETERMINING WHERE TO CROSS THE WATERCOURSE

All watercourse alterations require planning before submission to regulatory agencies. The proponent must be in compliance with applicable legislation. For more information refer to Legislative Requirements on p. 7. The proponent is solely responsible for ensuring that they have gathered and utilized all necessary information in the design of the watercourse alteration.

When new roads or transportation routes are being planned, there are two main ways to avoid negative impacts to watercourses:

1. minimize the number of watercourse crossing locations
2. properly select watercourse crossing locations

It is possible to minimize the number of watercourse crossings by following the contours of the land.

Where watercourse crossings are necessary, determine the appropriate location by following these principles:

- Align the road to cross the watercourse at right angles to prevent

any redirection of the flow in the watercourse.

- Locate the crossing in a section of the watercourse where the gradient is the lowest.
- Locate the crossing so that the outlet exits into a natural pool whenever possible. This reduces the downstream degradation of the watercourse.
- Watercourse crossings should be placed along a straight section of the watercourse with no braiding or obstructions.
- Avoid spawning grounds for salmonid species. These can be identified by the presence of small-to-medium-sized gravel substrate at the tail of a pool or in areas of groundwater upwelling.
- Avoid sites where bedrock outcrops are located. Blasting in watercourses to properly install a culvert can result in significant impacts. This would require a full review of the site-specific plans by the regulatory agencies.
- Avoid wetland areas that require significant alterations.

SITE ASSESSMENT

The site assessment is based on background research and on survey data collected at the proposed site.

Background research

Background research collected before visiting the field site is important for

planning. The background research collected should include:

- Geology and surficial geology (soils) maps
- Topography (preferably 1:10 000 scale) used to determine the size of the watershed that drains into the location of the proposed or existing watercourse crossing
- Land use (factor for runoff coefficient), which can be determined from aerial photographs
- Identification of existing access roads to reduce the footprint of the project (found using aerial photographs and road maps)
- Property owner identification to determine if approvals are needed to complete work
- Identification of wetlands and watercourses to avoid harm to the environment

Site visit

Visiting the site to collect information is required to make decisions about the most appropriate watercourse crossing structure. The information gathered during this visit may result in the need to make adjustments to the planned route. The site survey should provide enough information so that the designer or engineer can design a crossing that meets fish passage requirements. This information includes:

- Unidentified wet areas, rock outcrops or ledges
- Soil conditions (depth to bedrock)
- Identification of natural barriers
- Fish survey
- Identification of fish habitat and fish habitat features
- Water quality parameters
- Substrate classification
- Documentation of the existing condition of the site. This should be done through obtaining the following photographs:
 - a. From proposed structure location looking downstream
 - b. From proposed structure location looking upstream
 - c. Downstream looking at the proposed structure location
 - d. Upstream looking at the proposed structure location

- e. General view of the upstream and downstream ends, including the watercourse banks.

Creating a profile of the watercourse

The slope of the watercourse must be determined to ensure proper design for fish passage. To survey the watercourse, collect elevations both upstream and downstream of the proposed crossing location. Upstream and downstream locations depend on the watershed size.

- Watercourses with a watershed area $\leq 2.5 \text{ km}^2$ should be surveyed at minimum 30 m upstream and 30 m downstream from the proposed culvert inlet and outlet.
- Watercourses with a watershed area $> 2.5 \text{ km}^2$ should be surveyed at minimum 60 m upstream and 100 m downstream from the proposed culvert inlet and outlet.

The survey profile of the watercourse can be determined by taking measurements at stations on every top of riffle (high point) and every pool bottom (low point) along the watercourse thalweg and/or at stations every 5 m.

Record the thalweg elevation at each station and also the water surface elevations at the proposed culvert inlet and outlet. More survey stations can be added when doing a replacement culvert if the surveyor deems it necessary.

Station	Streambed Elevation (m)	Remarks
0+050	100.40	Bottom of pool
0-025	100.50	Top of riffle
0-020	100.35	Proposed culvert inlet
0-015	100.20	Bottom of pool
0-005	100.40	Top of riffle
0+000	100.25	Proposed culvert center
0+005	100.10	Bottom of pool
0+015	100.30	Top of riffle
0+020	100.15	Proposed culvert outlet
0+025	100.00	Bottom of pool
0+035	100.20	Top of riffle
0+050	99.90	Bottom of pool

Figure 1. This is an example of site survey data taken at a proposed 1.8 m diameter x 40 m long culvert in a watershed size that is less than 2.5 km².

Determine the watercourse slope

The watercourse slope is the vertical drop from the streambed thalweg elevation location at the upstream inlet **invert** of the proposed culvert to the streambed thalweg elevation at the first natural undisturbed riffle.

This undisturbed riffle is located at a distance of three times the culvert diameter (or width) plus a minimum of 3.5 m downstream of the proposed culvert outlet. This value, or drop in elevation, is then divided by the length between these two points and is usually expressed in percentages or degrees.

Use the site survey data collected as shown in Figure 1 to create a watercourse profile as illustrated in Figure 2. The designer can then place the proposed culvert along the profile as shown in Figure 2.

$$\text{Slope} = ((A-B)/L)*100$$

Where,

- A** is the upstream control located at the thalweg elevation of the existing watercourse at the proposed culvert inlet.
- B** is the downstream control thalweg elevation at the first natural undisturbed riffle located at a distance of 3 times the culvert diameter plus a minimum of 3.5 m downstream of the proposed culvert outlet.
- L** is the distance between A and B.

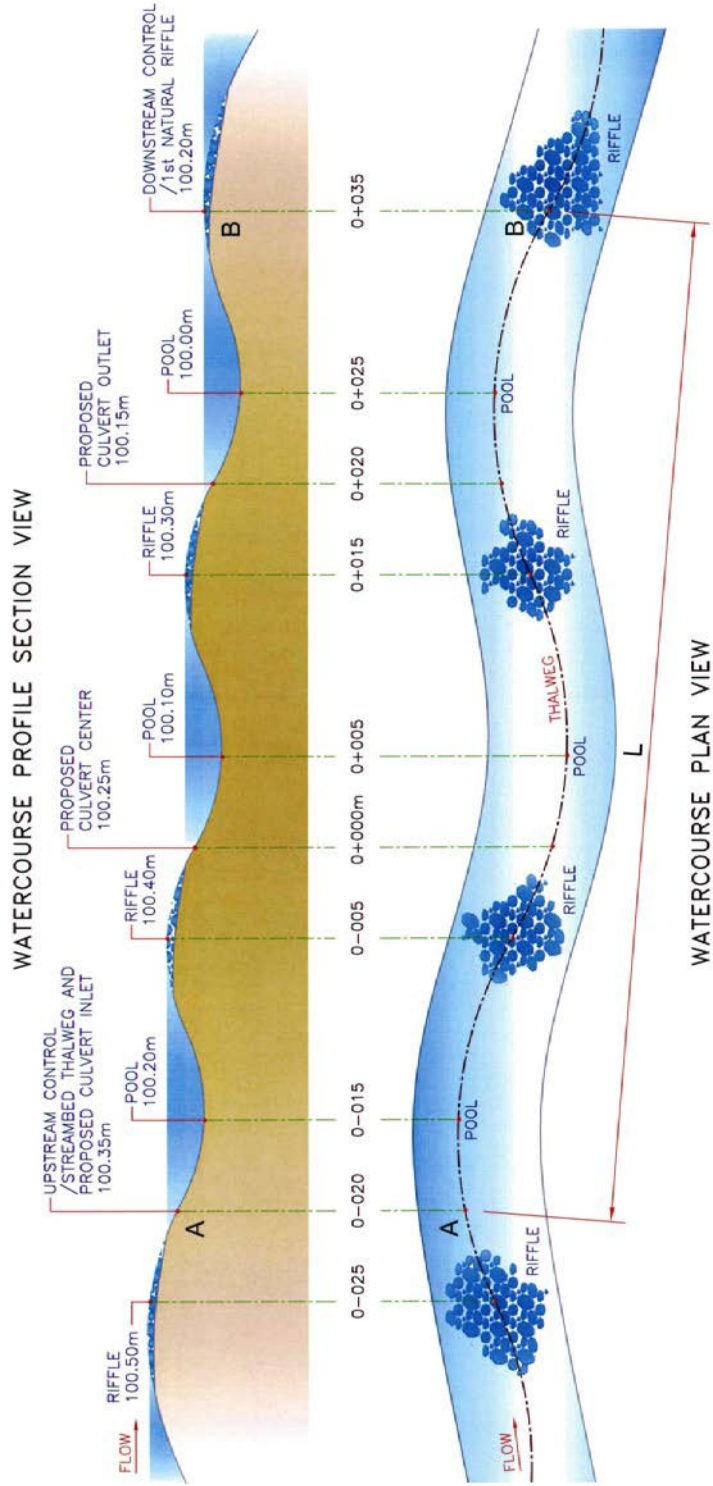

Figure 2. This watercourse drawing was created using the data from the site survey example in Figure 1 (above).

DESIGNING FISH PASSAGE FOR CULVERTS

Ensuring successful fish passage can be complicated to design, and requires careful installation and on-going maintenance. If you are unsure that your structure will adequately provide fish passage, please send a request for Regulatory Review (see Appendix B for details) to the nearest Fisheries and Oceans Canada regional office. A list of these offices can be found at: www.dfo-mpo.gc.ca/pnw-ppe/contact-eng.html.

CULVERTS WITH FISH HABITAT

Open-bottom structure (metal or concrete)

The open-bottom culvert is a bridge-like structure supported by footings that allows the retention of substrate within the culvert (see Figure 3). An open-bottom structure has a naturalized streambed. Retention of streambed material within the structure mimics conditions found in the watercourse, thus, minimizing any impact upon fish passage and fish habitat.



Figure 3. Example of a properly installed open-bottom structure.

Construction considerations

- The culvert is to be sized large enough so that the flow is not constricted (1:100 year flood flows). Any increase in flow through the pipe from what naturally occurs can **scour** the bed of the watercourse and cause habitat degradation.
- The construction of the footings must not alter the flow of the watercourse.
- The footings must be continuous, and the depth of the footings must extend below the thalweg depth.
- The area excavated for placement of the abutment needs to be backfilled to the natural streambed elevation with unshrinkable fill. It needs to be installed in compactable lifts not more than 0.3 m at a time to prevent **dewatering** of the streambed.

The advantages of the open-bottom structure can be negated if the structure is not of adequate size or does not maintain the original streambed.

For example, if the culvert is undersized or the streambed alignment is moved and armouring of the bed occurs, the hydraulic characteristics of the structure begin to deteriorate the “naturalness” of the channel (see Figure 4).



Figure 4. Example of a poorly installed open-bottom structure.

If the work partly or entirely destroys the watercourse, it must be realigned between the footings, ensuring:

- water is not lost through interstitial spacing by adding an appropriate amount of fines (see p. 27).
- the surface layer of the watercourse bed is similar to the natural substrate of the watercourse.
- a low-flow channel (thalweg) is incorporated matching the natural watercourse so that the water is concentrated during periods of low flow.

- that if the natural stream bottom has boulders that this is mimicked. Add boulders roughly 1.5 times the maximum size found in the watercourse. Embed these boulders into the substrate at 30% of their diameter. These boulders should be placed every 5 to 10 m in an alternating pattern.

Embedded culvert

Embedded culverts are culverts filled with boulder/cobble mix in order to create an environment similar to a natural watercourse (see Figure 5). This fill can allow adjustments in minor ways to changing conditions. Sediment transport, fish passage, flood and debris conveyances within the culvert are intended to function as they would in a natural channel.



Figure 5. Example of an embedded culvert.

Culverts designed for embedment should be sized wider than the channel width (1.25 bank full width) to ensure the watercourse is not constricted. If the channel is constricted, there can be significant alteration to the watercourse flow characteristics. A hydraulic jump

can develop within the inlet due to increased water velocity through the culvert and in the [tailwater](#). This can result in [perching](#) of the culvert, and loss of material from within the culvert. The bed inside the culvert has a gradient similar to the adjacent watercourse [reach](#).

Minimum size for an embedded culvert

The minimum culvert size of an embedded culvert is 4000 mm in order to have easy access for maintenance and clean up. It is not feasible to embed smaller culverts as the material in the pipe will not be large enough to remain in place.

Advantages of an embedded culvert

When a culvert is properly installed and sized to maintain the natural watercourse channel width, its grade is at the same slope as the watercourse and has the same sediment transport characteristics. This imposes no changes or delays in the upstream migration of fish. Spans that simulate the natural watercourse width enable passage of high flows without significantly increasing water depth and velocity. With reduced flow constriction at the outlet, there is less risk of tailwater scouring, which would result in a perched culvert. This structure can provide unrestricted passage for all size classes of fish up to design flows.

Note: Energy dissipation pools are not required for embedded culverts.

Disadvantages of an embedded culvert

The installation of an embedded culvert is more complex than the installation of a non-embedded culvert. The amount of culvert area lost to embedding must be accounted for in the sizing of the

structure, resulting in a larger pipe size. Filling the culvert with adequately sized material can be done using machinery when the culvert is large enough. Smaller culverts will require placement by hand, which can be very difficult.

Design and construction considerations

- The pre-existing watercourse slope in the proposed work area is $\leq 3\%$.
- Embedded culverts are typically buried a minimum of $0.4 \times \text{Diameter (D)}$ of the culvert below the streambed at the same natural gradient (watercourse slope) and sized to maintain the natural watercourse channel width.
- The culvert should be filled to the natural streambed level using material sized to accommodate flood flows, such that the placed material will remain in the culvert. Also, individual rocks, sized 1.5 times the maximum size found in the natural watercourse, should be embedded 30% of their diameter every 5 to 10 m in an alternating pattern.

CLOSED-BOTTOM CULVERTS

A closed-bottom culvert is often considered to be the most economical type of stream crossing. However, there are many challenges associated with a closed-bottom culvert. If designed and installed incorrectly, fish trying to enter this type of culvert may encounter various obstructions such as perch height, excessive water velocity, and inadequate water depth. These obstructions restrict fish passage through the culvert barrel.

Water velocity within a culvert

Water velocity within a culvert is a function of the slope and roughness of the culvert, as well as the cross-sectional area and watercourse discharge. Culvert roughness is the most readily manipulated factor that influences velocity. A variety of methods for increasing culvert roughness can be used, including baffles, corrugations, and the placement of bedload materials. Each of these methods has the common objective of producing areas of lower velocity within the culvert that fish can use for resting in order to traverse the remainder of the culvert where velocities are much greater.

Addressing inadequate water depth

A variety of methods are used to address inadequate water depth in culverts including baffles, lowering the culvert inverts with respect to streambed, and lowering or decreasing the culvert slope, where feasible.

Baffles

Baffles are features added to a culvert in order to increase the hydraulic roughness of the culvert, thus, slowing flow. They also create a series of pools with

increased water depth and decreased water velocity that help with fish passage.

Baffles are not always feasible depending on the culvert size and the watercourse slope. In general, the shorter the culvert, the less length is available to account for the drop in elevation between the two control points. This is why baffles can only be installed in shallower watercourse slopes where shorter culverts are proposed.

Further information on culvert sizes and watercourse slopes is available in Appendix D.

When baffles are not required

Baffles may be omitted:

- If the channel is not considered a watercourse (e.g., irrigation channels, agricultural drains, drainage ditches, roadside ditches). Note, this does not include diverted watercourses.
- If a non-baffled culvert can be installed when the watercourse slope is relatively flat ($\leq 0.5\%$) and if the culvert (max. length of 25 m) and [energy dissipation pool](#) are designed and installed according to these *Guidelines* (see Appendix D).
- If the results of the qualified persons assessment indicate that no fish species that require fish passage are present and/or that the physical habitat cannot support the fish then passage is not required.

Types of closed-bottom culverts

Corrugated metal pipe round culvert

This type of culvert offers similar hydraulic characteristics to the concrete round culvert. Also, aluminum culverts have a longer life span than steel pipe. The advantage of corrugated pipe is lower pipe velocity (see Figure 6). However, when you add baffles to steel or aluminum pipe, the overall cost of these pipes is decidedly more expensive than a concrete culvert with baffles.

Corrugated metal (steel multi-plate) culverts provide a high roughness coefficient (**Manning "n"**) because of their corrugations, which slow the water velocity through the pipe. This makes it easier for fish to traverse the barrel.

The disadvantage of corrugated metal culverts is their susceptibility to invert rust out. As a result, they have a shorter life span than concrete culverts.



Figure 6. A corrugated metal pipe culvert being installed.

Circular concrete culvert

Circular concrete culverts can be used wherever there are no special limitations with respect to height of fill or to the various water levels that can be encountered upstream of the culvert (see Figure 7). When compared with other shapes, the circular shape of the pipe results in a slightly increased depth of flow. This can benefit fish migration under low flow conditions. Fish baffles can be easily manufactured in concrete round culverts.



Figure 7. Example of a circular concrete culvert with baffles.

Concrete box culvert

A concrete box culvert offers an advantage to the designer when a large end area is required in a low-fill situation (see Figure 8). In general, the culvert should be wider than high and be as wide as the watercourse banks. This type of culvert is relatively economical to install. It is also easily embedded and filled with good substrate for fish production. At low flow these culverts can be the best option.

A weakness of the box culvert is that it has a wide flat bottom. This characteristic will result in fish passage difficulties and/or obstructions during periods of normal to low flow. This challenge can be overcome either by installing baffles in the box culvert or by embedding it. For more information refer to the Embedded culvert section beginning on p. 17.



Figure 8. Example of a concrete box culvert.

Metal pipe arch culvert

The pipe arch (see Figure 9) offers a similar hydraulic advantage to that of an open-bottom structure: the increase in the upstream water stage is minimized due to a similar wide bottom area.

Consequently, this shape is particularly useful where depth of cover is limited. Its wide, flat bottom may result in fish passage difficulties or obstruction during periods of normal to low flow. This can be overcome by installing baffles in the culvert or by embedding it. For more information refer to the Embedded culvert section beginning on p. 17.



Figure 9. Example of a metal pipe arch culvert.

CULVERT SIZE

Length

The length of the culvert is dictated by the width of the proposed roadway; however, the culvert should be aligned as much as possible with the alignment of the natural watercourse channel. The watercourse is not to be redirected into a roadside ditch in an effort to shorten the culvert. The use of headwalls and wingwalls at the culvert ends can substantially reduce the culvert length.

Diameter or span/rise

It is incumbent on the owner to verify the culvert capacity for passing 1:100 year flood flows. The designer needs to follow a standard method for these calculations that account for:

- rainfall runoff coefficients
- the slope of the culvert
- the amount of culvert that is embedded below the natural streambed
- the culvert material
- the addition of baffles

Non-baffled culverts

The minimum culvert size in a fish-bearing watercourse is 750 mm.

Baffled culverts

Past experiences demonstrate that culverts with a diameter <1200 mm that require baffles are difficult to maintain and keep open. Therefore, a diameter of 1200 mm is the minimum size of culvert to use when baffles are installed.

Baffles can occupy between 15% and 30% of the cross-sectional area for most culvert installations. The reduced cross-sectional area must be taken into consideration when calculating the culvert 1:100 year flood flow capacity.

Table 1 shows typical culvert cross-sectional open areas with and without baffles.

CIRCULAR CULVERTS

Size Diameter	X-Sectional Open Area	X-Sectional Open Area above 500mm high Baffle
(mm)	(m ²)	(m ²)
1220	1.17	0.72
1525	1.82	1.30
1830	2.63	2.05
2135	3.58	2.94
2440	4.67	3.98
3050	7.29	6.51
3660	10.5	9.68

BOX CULVERTS

Size Span x Rise	X-Sectional Open Area	X-Sectional Open Area above 500mm high Baffle
(mm)	(m ²)	(m ²)
1830 x 1220	2.10	1.25
1830 x 1830	3.22	2.37
2440 x 1830	4.33	3.18
2440 x 2440	5.82	4.67
3050 x 2440	7.31	5.85
3050 x 3050	9.17	7.71
3660 x 3050	11.0	9.27
3660 x 3660	13.3	11.5

Table 1. Cross-sectional open areas with and without baffles.

MINIMUM FLOW DEPTH AND FLOW VELOCITY

Non-baffled culverts

The minimum flow depth is dependent on the diameter of the culvert and is maintained while satisfying the requirements of the invert elevations and energy dissipation pool. This will ensure that during periods of low flow, the water in the pipe is **backwatered** the entire length of the barrel (see Figure 10). Heavy rainfalls throughout the year will increase the velocities within the pipe, and some fish may not be able to traverse the culvert during these high flows depending on their swimming abilities. However, once the rains stop and the velocities decrease, the fish will pass through the culvert.

Baffled culverts

When baffles are used in a culvert, the minimum water depth to ensure fish passage is 150 mm above the notch sill. The minimum flow depth should be maintained while satisfying the invert elevations and energy dissipation pool requirements. The June Q60 flow has been chosen as a standard for fish passage culvert design in the Maritimes (see Appendix G). This means that in June, the notches will be full 60% of the time, which should satisfy the life processes of fish requiring migration in June. There is normally enough water during the spring and fall migration periods to ensure fish passage for migrating adults. Weaker swimming fish will be able to pass through the culvert when velocities are reduced. The use of baffles, notch sizes, invert elevations, baffle spacing, and energy dissipation pools ensure that the fish

passage requirements associated with minimum flow depth and velocity are met. Depending on the culvert diameter, length and the drop between baffles, the watercourse slope where baffles can be installed will also vary (see Appendix D).

Flow through the culvert

Occasionally a culvert installation ends up with the water flowing under the culvert instead of into the pipe. This **undermining** means fish cannot traverse the barrel. To prevent this the designer or engineer must either require the installation of a **cut-off wall** or the use of a clay/bentonite plug under the culvert inlet invert to rebuild the upstream end so that the water flows through the pipe. Water can also escape through joints between culvert lengths. This can be prevented by parging the gaps or properly installing gaskets.

CULVERT ALIGNMENT

The preferred alignment is the same alignment as the watercourse. Watercourse re-alignments are not covered under these *Guidelines*. The watercourse is not to be re-directed into a roadside ditch in an effort to shorten the culvert. Should realignment of the watercourse be necessary, a standard application is to be submitted for regulatory review (see Appendix B).

INLET AND OUTLET DESIGN

When it comes to designing and reconstructing the watercourse immediately outside the culvert on both ends (upstream and downstream), it is important to:

- Minimize disturbance to the area
- Provide a suitable impermeable substrate that will reduce unnecessary loss of watercourse flow
- Ensure you do not use filter fabric or geo-textiles of any form in the reconstructed watercourse
- Provide [riparian](#) vegetation such as shrubs and trees along the watercourse edge and above the high water line to help stabilize and generally restore the area as habitat for fish
- Construct an energy dissipation pool at the culvert outlet. These pools decrease the flow velocity, which reduces scour and [erosion](#) to the downstream end of the culvert. The pools also provide resting areas for fish prior to traversing the culvert.

CULVERT INSPECTION AND MAINTENANCE

Inspection

Proponents (owners) are responsible for regular inspection and maintenance of their structures. If the proponent has a large network of structures, a database is a great way to keep up-to-date, accurate information about their structures and to demonstrate due diligence.

Natural debris from upstream bedload movement or from riparian areas can move downstream in heavy flows. An anthropogenic structure like a culvert is a permanent structure that impedes the ability of the watercourse to change over time. This causes scouring, build-up of debris and blockages in the structure that will threaten both fish passage and the integrity of the structure. Therefore, an on-going inspection and maintenance program is necessary to prevent problems and/or the complete failure of the structure.

The structure, including the energy dissipation pool and the [downstream control](#), should be inspected in early spring and early fall before fish migration periods and after major storms to ensure that any maintenance that is required is addressed.

Maintenance

Maintenance to a structure includes work required to retain the structure or restore it to its original state. It does not include the replacement or removal of the structure. The footprint of the structure should not increase as a result of maintenance work.

It is good practice to clearly mark all crossings on fish streams, allowing maintenance staff to readily identify them. If an electronic database is developed using a GPS, all fish streams should be identified and located on a map.

Debris

Areas prone to serious debris or erosion problems require special consideration and should be accounted for in the choice of structure.

Culverts should be cleared of debris as soon as possible. Small accumulations of debris should be removed by hand. Properly designed trash racks should be built to accommodate fish passage. These may require frequent maintenance. If debris is a persistent problem, then replacement of the structure to permit debris movement should be considered.

Beaver dams at the inlet

Beaver dams can prevent fish passage as well as threaten roads. Frequent maintenance is required if beaver dams are present. Beaver problems can be so persistent in some areas as to be a significant factor in design choice. Bridges and open-bottom structures are less prone to beaver problems than culverts.

NON-BAFFLED CULVERTS

In non-baffled culverts, there is no placement of material within the culvert. Over time, the section of the watercourse that has a culvert will reinstate itself to rebalance with the upstream environment. Non-baffled culverts that are properly designed and installed provide for fish passage. For non-baffled culverts refer to Appendix H, example 2.

Determining the culvert inlet and outlet invert elevations

- The **culvert inlet invert** elevation is equal to the **upstream control**. The upstream control is the existing streambed thalweg elevation.
- When a proposed culvert installation has an effective watercourse slope of $\leq 0.5\%$, install the culvert as indicated in Figure 10.
- The **culvert outlet invert** elevation is to be set at 0.2 times the culvert diameter/height to a maximum of 400 mm below the downstream control (riffle/step elevation or the first natural undisturbed riffle). This downstream control is located at a distance of 3 times the culvert diameter/width plus a minimum of 3.5 m downstream of the culvert outlet to allow for stability of the downstream end of the pool (see Figure 11).
- The elevation of the first natural undisturbed riffle (downstream control) is to be 0.2 times (D) up to a maximum of 400 mm higher than the culverts outlet invert elevation. This downstream control is not to be altered.

Note: When sloped end sections or flared end sections are used with an apron, those sections must be included in the calculation of the length and the slope of the culvert.

Fish passage design steps for non-baffled culverts:

1. Determine the culvert inlet and outlet invert elevations
2. Determine the dimensions of the energy dissipation pool



Figure 10. Culvert installation when fish baffles are not needed. “A” is the upstream control located at the thalweg elevation of the existing watercourse at the proposed culvert inlet. “B” is the downstream control thalweg elevation at the first natural undisturbed riffle. “D” is the diameter or width of the culvert.

ENERGY DISSIPATION POOL DESIGN

Note: Energy dissipation pools are required for all closed-bottom culverts except those that are embedded.

The energy dissipation pool should be sized to ensure stability of the pool during peak flood flows. Figures 11 and 12 illustrate the design principles that should be followed for proper functioning of the energy dissipation pool.

In addition:

- The energy dissipation pool should be stabilized to prevent scour and erosion. This means that: (a) the size of **riprap** stone in the dissipation pool must be sufficiently large to withstand velocities produced by the 1:100 year flood event; (b) three boulders should be placed in the pool in a triangle pattern in order to further dissipate energy (see Figure 12). For culverts equal to or less than 1.5 m, the diameter of the boulders should be approximately 0.75 m. For culverts greater than 1.5 m the boulder diameter should be approximately 1 m.
- Do not use any **filter fabric** in the construction of the pool.
- The depth of the pool must be a minimum of 1 m.
- The width at the bottom of the dissipation pool is 2 times the culvert diameter/width (D).
- The length at the bottom of the dissipation pool is 3 times D
- At the downstream end of the dissipation pool (at $3D$), the slope up to the existing elevation of the natural stream is to be constructed at no more

than 1:2 (vertical:horizontal). This area of the pool is to have riprap scour protection to withstand a 1:100 year flood event (see Figure 12).

- A filtration layer of gravel Type 2 should be placed under the riprap to prevent erosion.
- Add the appropriate amount of fines to the rock mixture to ensure that water will not be lost through interstitial spacing. This can be achieved through the addition of fine granular material, gravel borrow or pit run material (20% fines, does not include clays). The pool will have to be “washed” thoroughly and the wash water pumped away prior to releasing the stream permanently into the culvert.

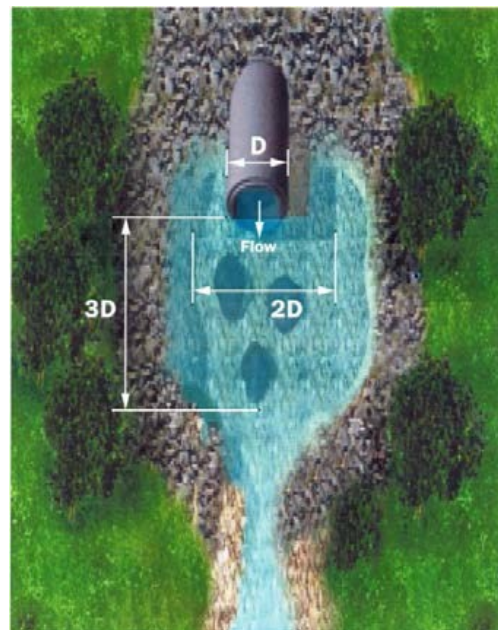

Figure 11. Energy Dissipation Pool Dimensions

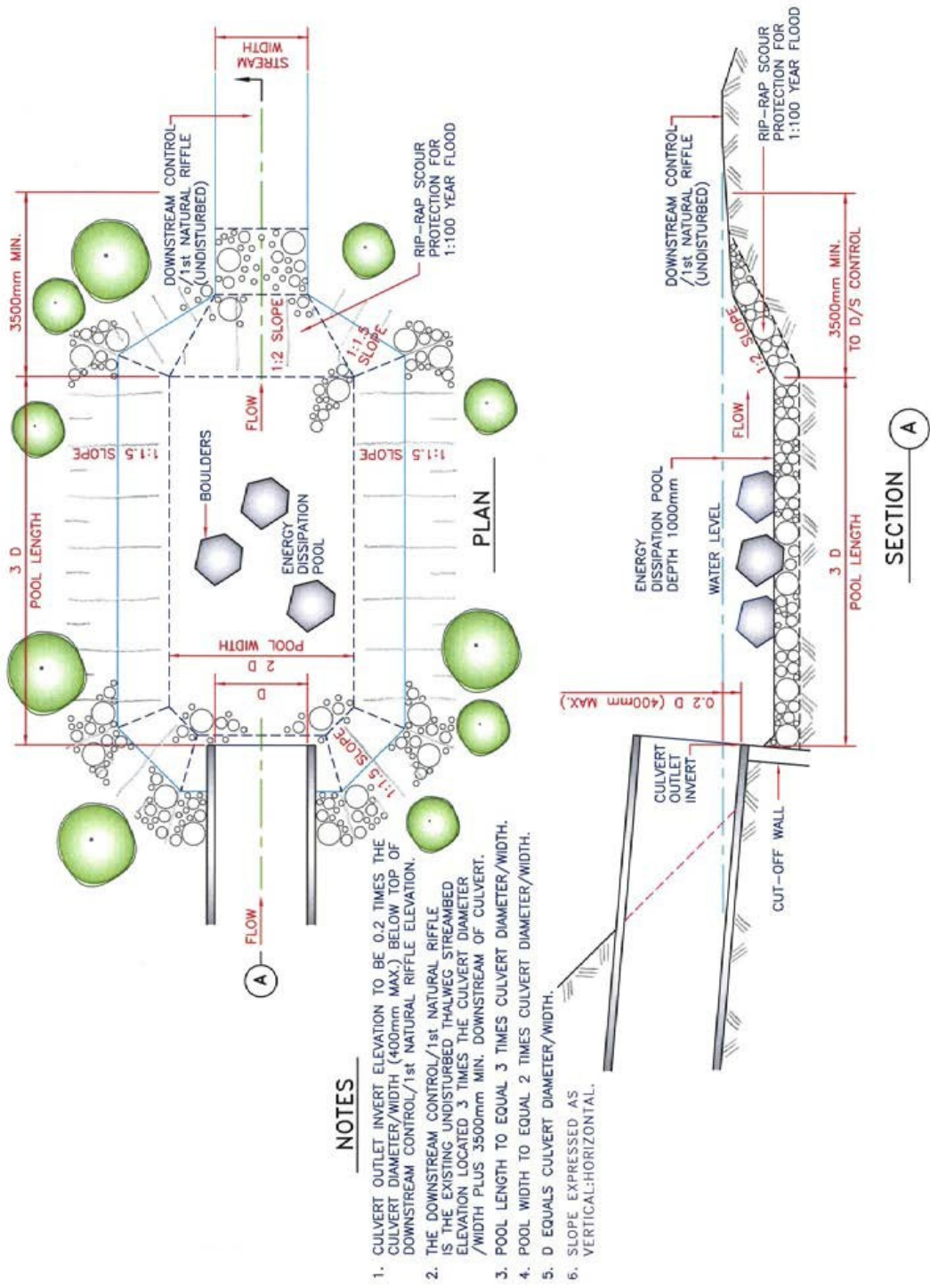

Figure 12. Energy Dissipation pool design for a non-baffled culvert

BAFFLED CULVERTS

Determining the culvert inlet and outlet invert elevations

- For a culvert installation that has an effective watercourse slope $> 0.5\%$ it may be necessary to add baffles within the culvert to allow for appropriate fish passage (see Figure 13). Install the culvert so that it has a constant slope throughout its length except where settlement is anticipated. In situations where settlement is anticipated, the culvert should be installed with an appropriate camber.
- Set the culvert inlet invert elevation at the same elevation as the existing watercourse thalweg elevation at the upstream control.
- Carefully determine the culvert outlet invert elevation to ensure that the baffle top elevation at the lowest baffle is equal to the downstream control riffle/step elevation. This downstream control is the thalweg elevation of the streambed at the first natural undisturbed riffle/step. It is located at a distance of 3 times the culvert diameter/width plus a minimum of 3.5 m downstream of the culvert (see Figure 14). If the first downstream control falls within the location of the proposed plunge pool the design must use the next downstream riffle in the design and calculations. This is to ensure proper backwatering into the culvert and to prevent a perched culvert. For baffled culverts refer to Appendix H, examples 1, 3 and 4.
- Determine the location of the lowest baffle at the same time you determine the outlet invert elevation as there is a correlation between the two placements. The lowest baffle should be at most 1.25 m from the downstream end of the culvert (see Figure 14).

Note: When sloped end sections or flared end sections are used with an apron, those sections must be included in the calculation of the length and slope of the culvert and to determine the location of the baffles.

Determining the dimensions of the energy dissipation pool

The determination of energy dissipation pool dimensions is the same for culverts with or without baffles. The standard process is described on p. 27. Figure 14 is an example of an energy dissipation pool for a baffled culvert.

Fish passage design steps for baffled culverts:

1. Determine the culvert inlet and outlet invert elevations
2. Determine the dimensions of the energy dissipation pool
3. Determine the baffle and notch sizes based on the fish species present in the watercourse.
4. Determine the baffle spacing based on the fish species present in the watercourse.

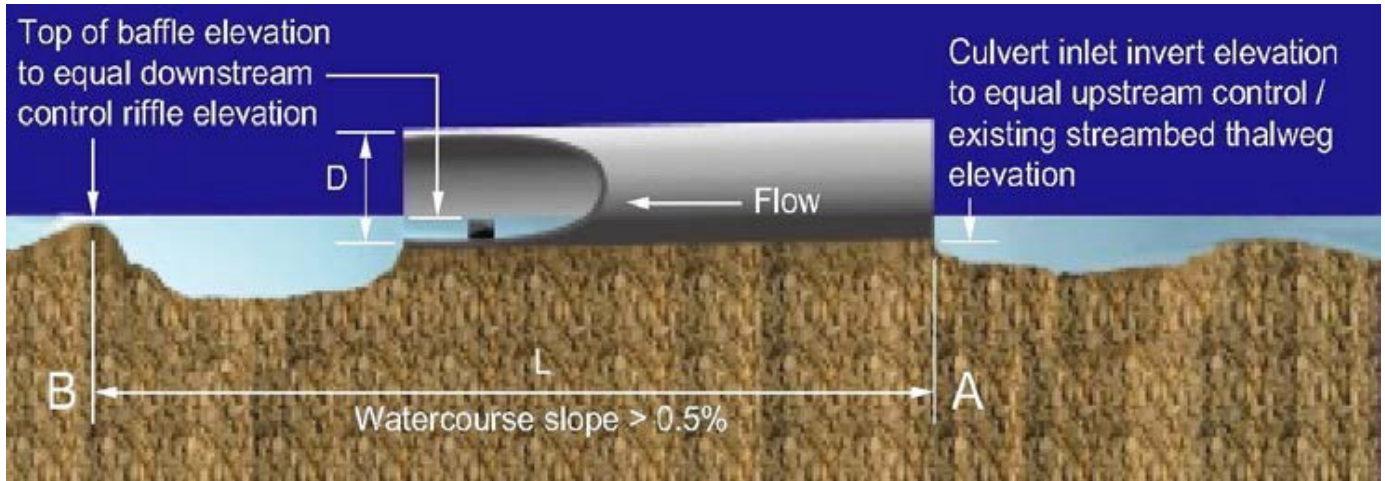

Figure 13. Installation of a culvert with baffles. “A” is the upstream control located at the thalweg elevation of the existing watercourse at the proposed culvert inlet. “B” is the downstream control thalweg elevation at the first natural undisturbed riffle. “D” is the diameter or width of the culvert.

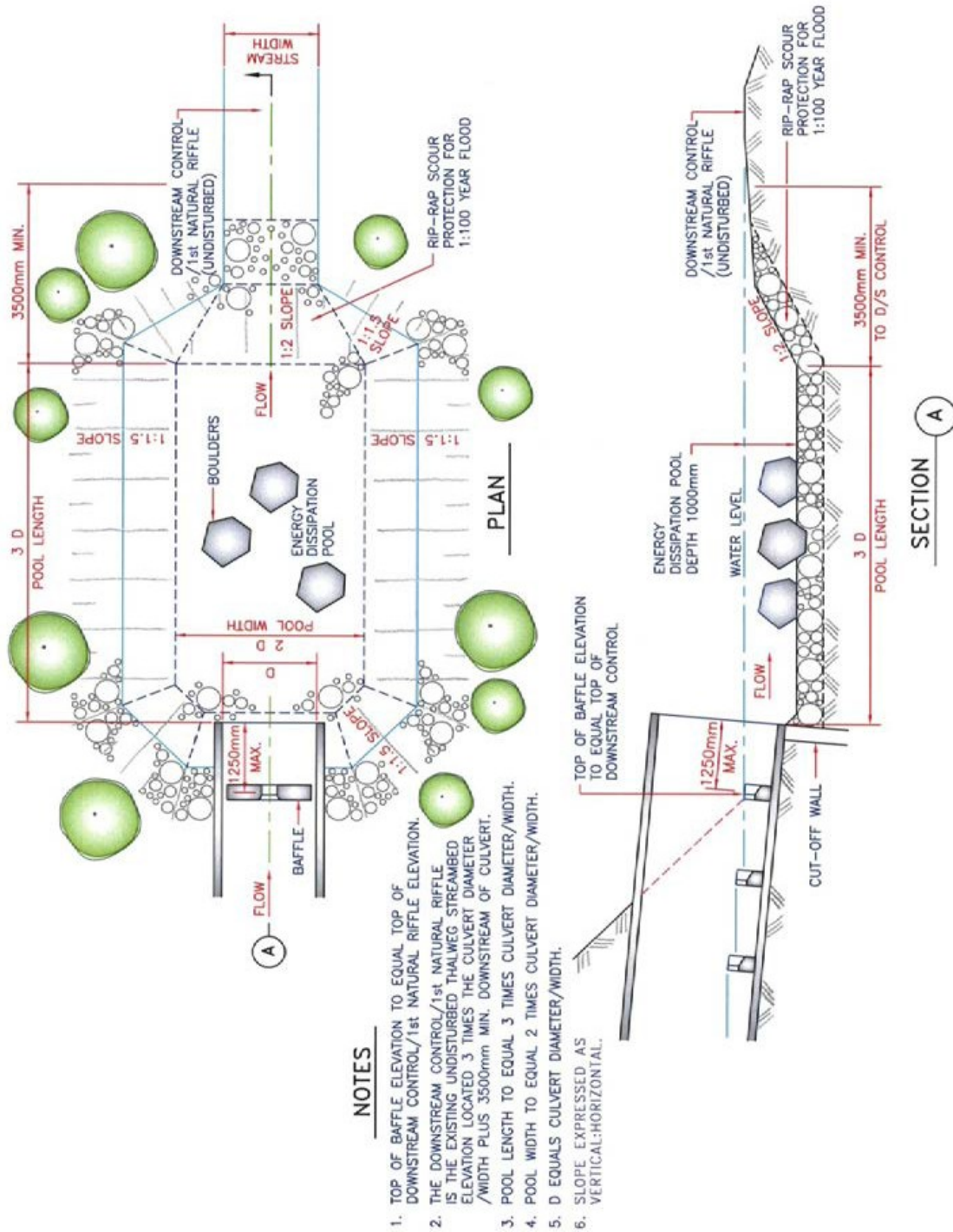

Figure 14. Energy dissipation pool design drawing for a baffled culvert

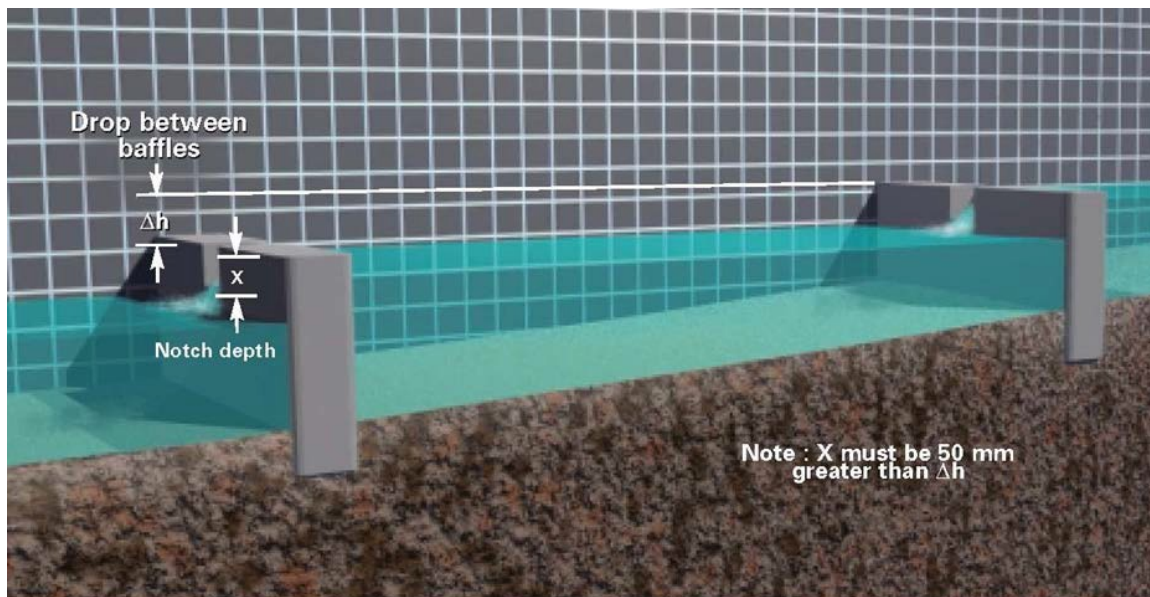

Figure 15. Illustration of a drop between baffles

Determining baffle notch sizes

In order to ensure that there is enough water volume between the baffles for fish to rest in, the baffle height must be 500 mm. Baffle width is based on structural integrity and is a manufacturing determination.

The notch is normally located in the middle of the baffle. However, it can also alternate from one side to the other. The notch size (width and depth) is designed to have enough water for fish passage in the notch during periods of lower flows (June Q60) in the watercourse. There may be times during the year that there is not enough water going over the notch to allow passage of fish. In general, this is a temporary concern usually alleviated by the next rainfall.

The notch depth is a minimum of 50 mm greater than the drop between baffles, ensuring that the notch will generally be submerged during periods of fish migration (see Figure 15).

The notch of the baffle should be sloped 1:2 in a downstream direction (see

Figures 16 and 17). The edges of the baffle should be rounded by 1/3 of the baffle width at the upstream side of the baffle. These small details in notch design make the surfaces more gradual and help fish pass through the notch more easily.

Table 2 (see p. 34) shows proper notch sizes based on the minimum amount of flow required to fill the notch. If the watercourse does not have the minimum flow required for a certain size notch, then the design must follow the next lowest minimum flow.

This decreases the notch size ensuring a full notch at the June Q60. For example if the June Q60 flow is calculated to be 0.052 m³/s the design must default to the next minimum flow of 0.045 m³/s to ensure the notch is full.

The June Q60 flow can be calculated by using a prorated calculation method wherein the hydrometric data from Environment Canada is used and prorated to the watercourse crossing site using standard runoff coefficients (see Appendix G).

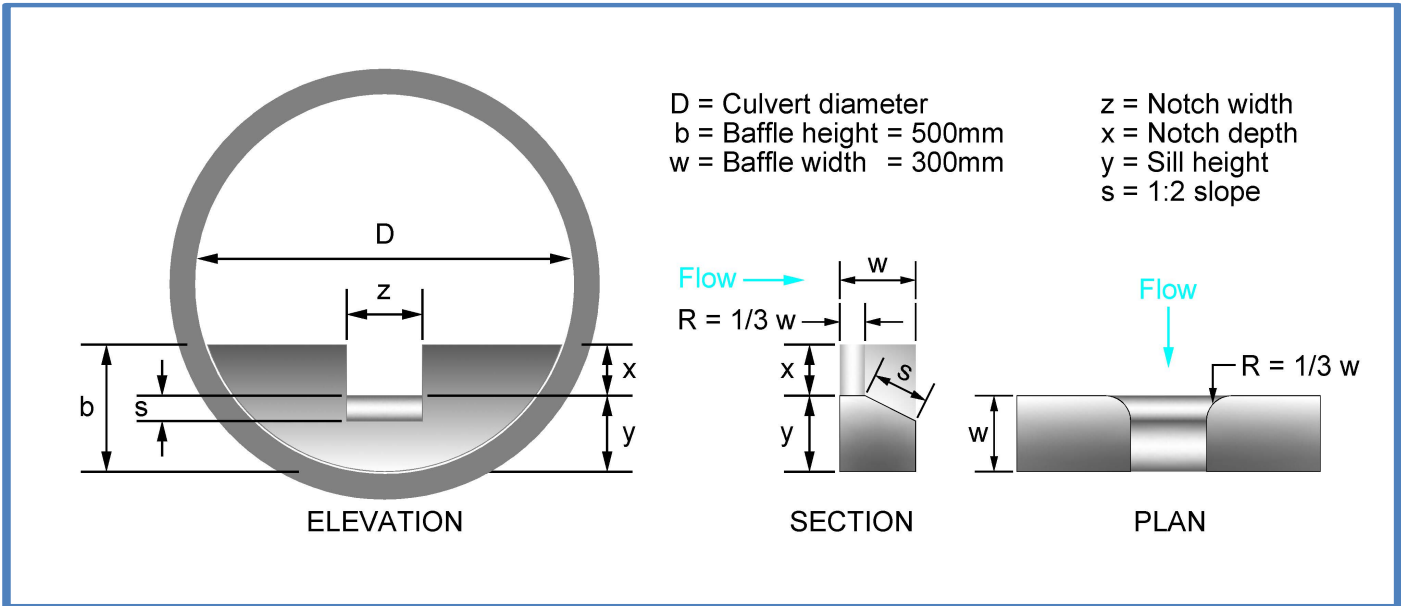

Figure 16. Baffle notch sizing for concrete culvert baffle (cross-sectional area)

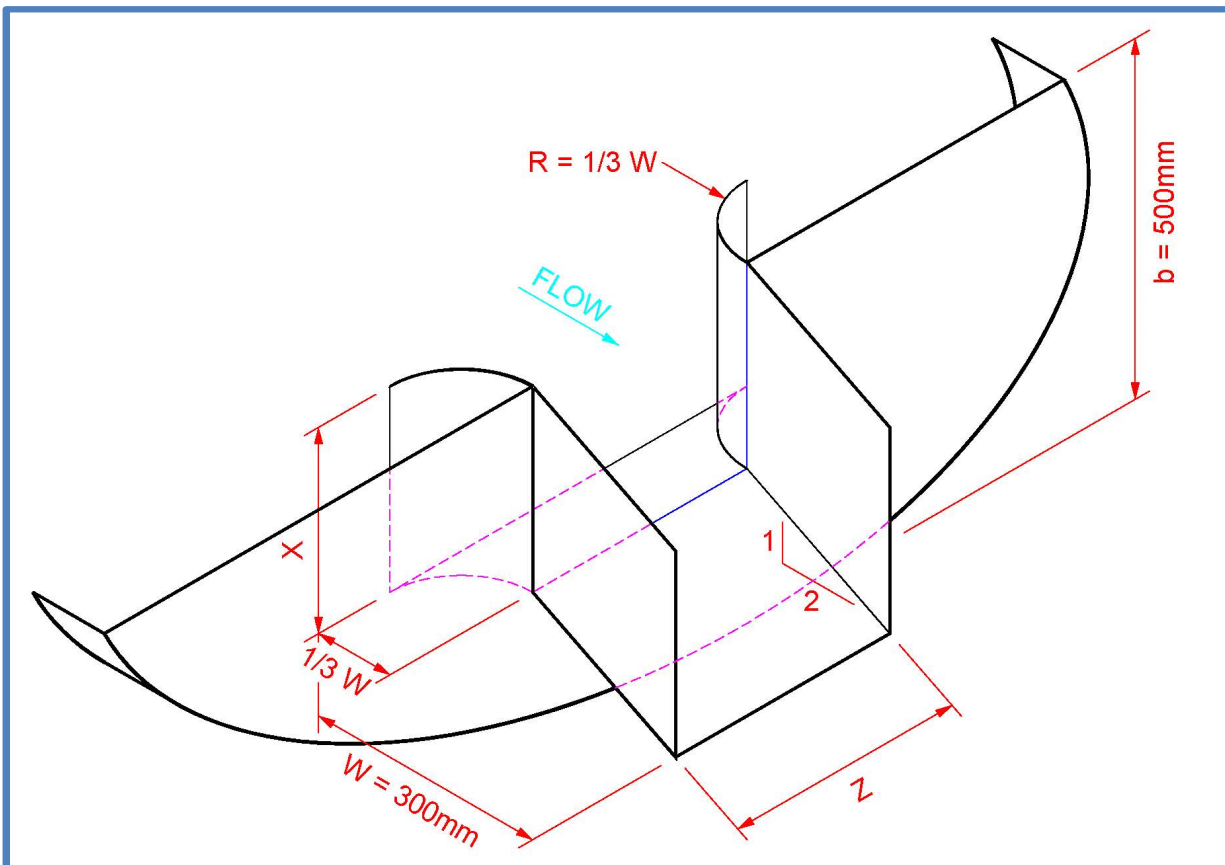

Figure 17. Baffle sizing for metal culvert baffle

Minimum flow to fill notch area (June Q_{60})	Notch width (z)	Notch depth (x)	Baffle height (b)	Max. drop between baffles (Δh)
0.023 m ³ /s	150mm	200mm	500mm	150mm
0.030 m ³ /s	200mm	200mm	500mm	150mm
0.045 m ³ /s	300mm	200mm	500mm	150mm
0.064 m ³ /s	300mm	250mm	500mm	200mm*
0.085 m ³ /s	400mm	250mm	500mm	200mm*
0.107 m ³ /s	500mm	250mm	500mm	200mm*
0.128 m ³ /s	600mm	250mm	500mm	200mm*

**When Rainbow smelts are present the Δh is 150 mm*

Table 2. Notch sizes derived using the Larinier (2003) formula.

$$Q = 0.4 z \sqrt{2g} h^{1.5} (1 - (h - \Delta h)/h)^{1.5 \cdot 0.385}$$

where

Q = full notch flow

z = notch width

h = notch height

Δh = elevation difference between baffles

g = gravitational acceleration

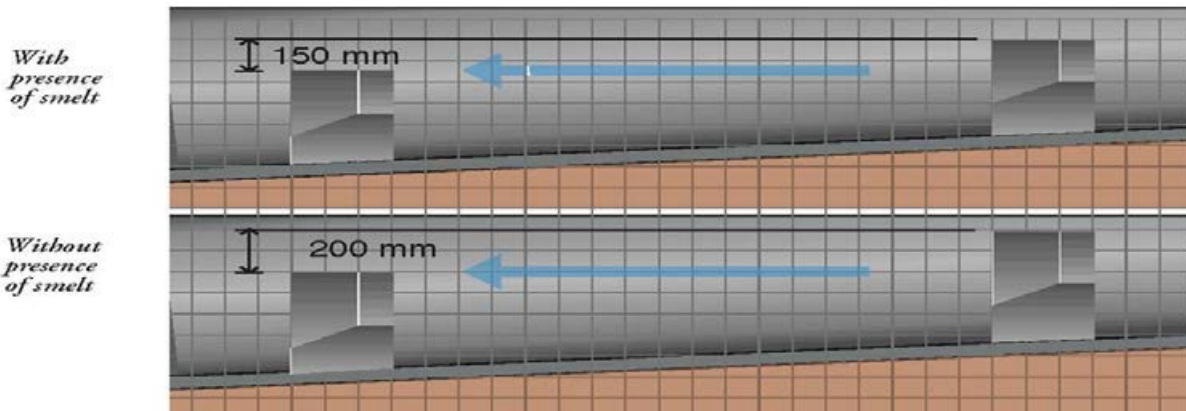

Figure 18. Maximum drop between baffles when Rainbow smelt are present as opposed to the maximum drop between baffles when Rainbow smelt are not present.

Drops between baffles

Drops between baffles should be ≤ 200 mm. However, the drop should be ≤ 150 mm in locations where the watercourse is used by Rainbow smelt (see Figure 18).

Baffle spacing

Baffle spacing is influenced by notch depth, depth of water, culvert fabrication methods, fish species behavior and fish swimming abilities (see Figure 19). These factors have been taken into consideration in these *Guidelines* by setting standards for baffle height, baffle drops, spacing minimums and maximums and by setting standard notch sizes. For examples of Typical Baffle Placement, refer to Appendix I.



Figure 19. Example of baffle spacing

The minimum distance between baffles should be 1.63 m in order to dissipate enough flow energy between baffles (see Figure 20). The maximum spacing of baffles depends on the prescribed drops between water surfaces in pools and the established [culvert slope](#). For more information on how to calculate maximum baffle spacing, refer to Figure 21.).

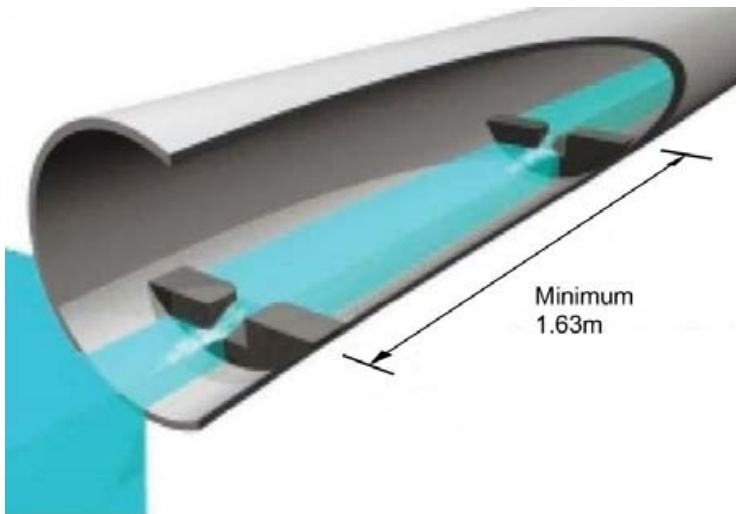

Figure 20. Minimum baffle spacing

$$I = \Delta h / \text{culvert slope}$$

Where,

I is the maximum spacing between baffles.
 Note: If the culvert is prefabricated, choose the spacing that will fit best with the manufacturer's specification. That will still be less than I. I will also determine the location of the most upstream baffle. You have reached the last baffle when the distance between a baffle and the upstream end of the culvert is less than I.

Δh is the maximum drop between baffles (0.20 metres (m) or 0.15 m when passage for smelt is needed).

culvert slope (%) is the gradient of the culvert.

Figure 21. Formula to calculate maximum baffle spacing

REMEDIATING EXISTING CULVERTS

If the existing culvert is not expected to require replacement in the near future (the next two or three years), but it does not allow for the passage of fish, then remediation may be necessary (see Figure 22). Depending on the height of the drop in elevation between the watercourse and the culvert, it can be remedied by: (a) retrofitting it with weirs or baffles installed downstream of the culvert ; or (b) by installing a chute at the culvert's outlet invert. There may also be other solutions such as downstream [fishways](#) or installing half culverts with baffles at the culvert's downstream invert.



Figure 22. Example of a culvert in need of remediation

Installing a chute is fairly easy and does not require collecting additional information as there are no in-stream alterations required. However, when the drop is more than 250 mm (10 inches), retrofitting is necessary.

Retrofitting culverts

Providing passage for fish species remains the objective for retrofitting culverts. As a result, the site survey for retrofitting a culvert is slightly different from the site survey for a new or replacement culvert. For step-by-step instructions on a new or replacement culvert site assessment, refer to p.12. Surveys for retrofitting a culvert require the collection of more information on the downstream end. The survey may need to extend 120 m downstream because this is the new design area that requires close attention.

Information to gather during the site survey for retrofitting an existing culvert

- Watercourses should be surveyed at minimum of 30 m upstream and 120 m downstream from the existing culvert inlet and outlet, respectively.
- The survey profile of the watercourse can be determined by taking measurements at stations on every top of riffle (high point) and every bottom of pool (low point) along the watercourse thalweg, and/or at stations every 5 m along the thalweg upstream and downstream of the existing culvert. Record the thalweg elevation at each station, the inlet and outlet invert elevations of the existing culvert, and also the water surface elevations at the inlet and outlet of the existing culvert. Record any significant variation of elevation inside and outside of the culvert.

To establish a true longitudinal section through the watercourse and culvert, survey turning points may be required over the roadway from one end of the culvert to the other end.

- A minimum of 5 cross sections to be taken 25 m downstream and upstream from the ends of the culvert to be surveyed as follows:
 - a. Cross-sections to be taken at right angles to the centerline of the culvert; and
 - b. A maximum of 5 m interval between stations. The following information should be recorded at each station:
 - i. Record the high water elevation from observation
 - ii. Note any scour around the culvert
 - iii. Identify and record the types of soil in the streambed and banks; e.g., sand, silt, fine gravel, coarse gravel, small boulders, large boulders, rock, and/or clay.

DESIGN CONSIDERATIONS WHEN RETROFITTING EXISTING CULVERTS

Barriers to fish passage can be resolved by retrofitting culverts using control structures such as weirs either within the existing culvert or downstream. These control structures should be designed with the same considerations as outlined in the Baffled Culverts section of these *Guidelines* beginning on p. 29. In addition, an evaluation should be done on the existing culvert to determine if fish passage requirements are effective.

Installing weirs

The weirs (see Figure 23) should be keyed into the banks of the watercourse to ensure their stability. It may be necessary to elevate the banks in order to retain water in the watercourse channel.



Figure 23. Concrete weirs are used as control structures in a watercourse to raise the downstream water elevation at a retrofitted culvert.

Weir construction materials

Engineered works such as concrete weirs, highway dividers, steel sheet piles or similar structures should be used for medium to large watercourses due to high flow velocities.

Step pools

If the proponent can commit to long-term monitoring and maintenance, a step pool design is acceptable if:

- It has 1, 3 or 5 **steps** where each step is no more than 20 cm, in a 6 channel width section of a small watercourse (drainage areas less than 2.5 km²).

Regular monitoring and maintenance of the site is necessary to ensure the steps remain intact.

Determining weir notch sizes

The weir should be at least 1300 mm in height. The weir notch sizes (width and depth) are designed so there is enough water for fish passage in the notch during periods of low flow in the watercourse. The weir notch size can be determined using step 3 of the fish passage design steps on p. 29. Notch depth is a minimum of 50 mm greater than the drop between weirs, ensuring that the notch will generally be submerged during periods of fish migration.

Determining weir spacing

The first downstream weir should be spaced according to step 2 of the fish passage design steps on p. 29 to create an energy dissipation pool at the end of the culvert. If additional weirs are required, space them according to site conditions.

The most downstream structure in the watercourse should be installed at the thalweg elevation of the brook (completely embedded), in order to keep backwatering in the culvert in case the streambed is eroded (see Figure 24).

WATERCOURSE PLAN VIEW

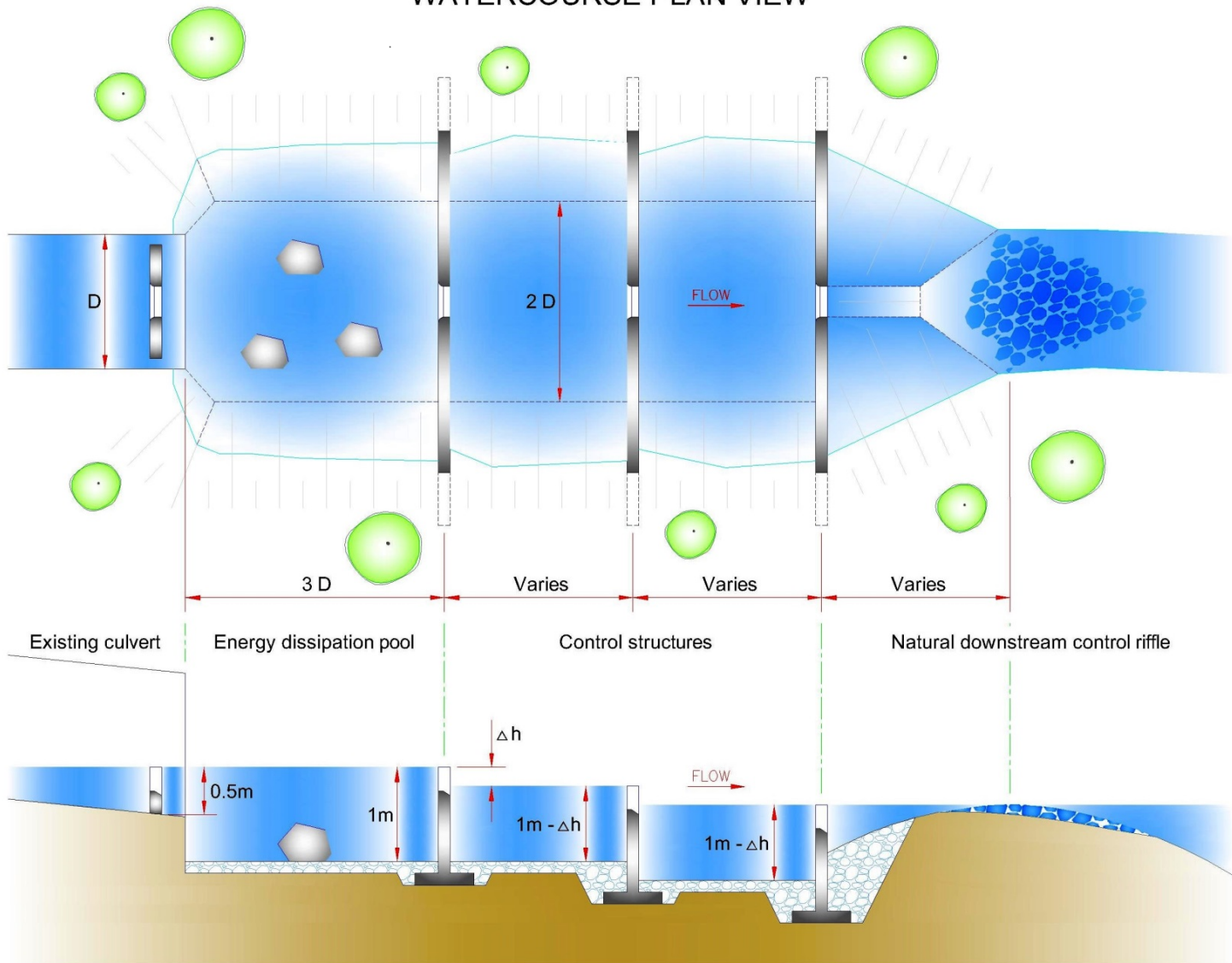

WATERCOURSE PROFILE SECTION VIEW

Figure 24. Control structures in a watercourse

DESIGN CONSIDERATIONS WHEN INSTALLING A FISH PASSAGE CHUTE

In many cases, the existing culvert's outlet invert elevation is too high above the downstream control elevation, causing perching. This is a vertical barrier to fish trying to swim upstream through the culvert.

As described in the "Remediating Existing Culverts" section, you can alleviate a vertical barrier issue using: (a) a control structure; or (b) a more economical fish passage chute (see Figure 25).

When a fish passage chute can be installed

You may install a chute (see Figures 26 and 27) at the outlet invert end of the existing culvert as a **temporary solution** until it is time to replace the culvert if all of the following criteria are met:

1. The height of the vertical barrier from the culvert's outlet invert elevation down to the downstream control elevation is less than 250 mm
2. The culvert length is less than 25 m
3. The culvert slope is less than 1%
4. The current culvert has been in place for at least 5 years and is structurally sound.

See Appendix J for the chute dimensions of round culverts for 900 mm, 1200 mm, 1500 mm, 1800 mm and 2400 mm pipes.



Figure 25. A chute installation on a culvert

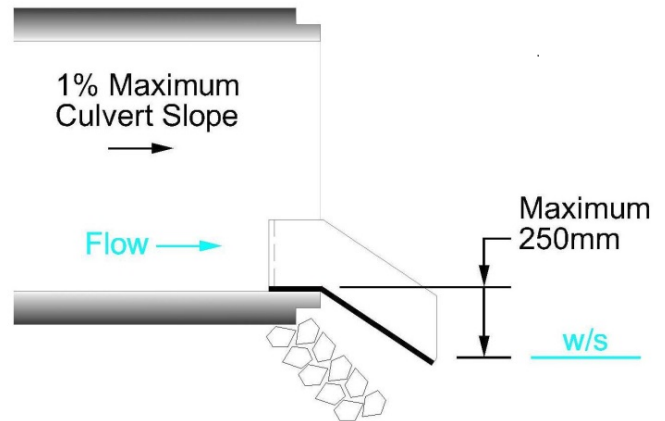

Figure 26. Culvert with a chute installed

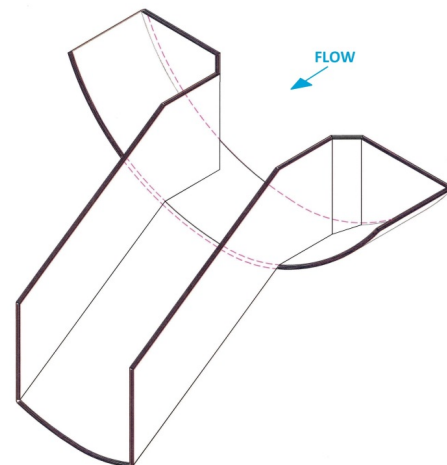

Figure 27. Typical fish passage chute

REFERENCES CITED

- Fisheries and Oceans Canada. 2012. *Guidelines of Fisheries and Oceans Canada for the design of watercourse crossings in Québec*. Maritimes Region, Diadromous Fish Division. DFO Document No. 96-01.
- Larinier, M. 2003. *Passé à poisson, expertise et conception des ouvrages de franchissement: Conseil supérieur de la pêche*. Paris. 336 pp.
- Government of Canada. *Species at Risk Act*. (S.C. 2002, c. 29).
- Savoie, R. and D. Haché. Fisheries and Oceans Canada. 2002. *Design criteria for fish passage in new or retrofit culverts in the Maritime provinces, Canada*. Gulf Region, iv + 38 pp. ISBN 0-662-66412-4. Catalogue No. Fs23-410/2002.
- Federal Interagency Stream Restoration Working Group. 1998. *Stream corridor restoration: principles, processes, and practices*. GPO Item No. 0120-A; SuDocs No. A.6/2: EN 3/PT.653. ISBN-0-934213-59-3.
- Fisheries and Oceans Canada. 1998. (April 1) *Guidelines for the protection of fish and fish habitat: The placement of culverts*. Maritimes Region, Final Draft, April 1. 101 pp.
- Conrad, V. and H. Jansen. Fisheries and Oceans Canada. 1996 (January). *Fish passage and habitat preservation for highway culverts in Eastern Canada*. Maritimes Region, Diadromous Fish Division. DFO Document No. 96-01.
- Government of Canada. *Fisheries Act*. (R.S.C., 1985, c. F-14).

GLOSSARY

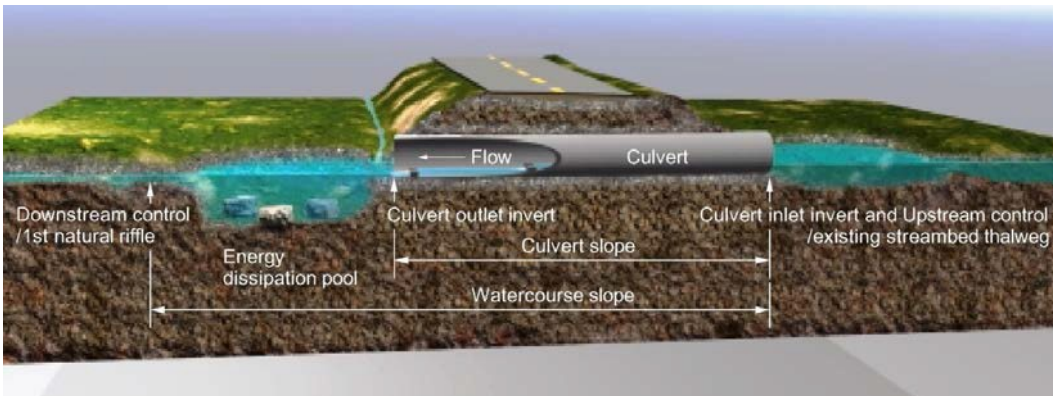

Figure 28. Illustration of general culvert installation terms.

Backwater

Water backed-up or retarded in its course as compared with its normal open channel flow condition, thus, creating a water level that is controlled by some downstream hydraulic control.

Baffle

Wood, concrete or metal device or partition mounted on the floor of a culvert to hold back or impede the flow of water and thereby increase boundary roughness and reduce the average water velocity in the culvert, which facilitates fish passage.

Bank full width

The edge of perennial vegetation right bank to edge of perennial vegetation left bank, usually equal to the width of the watercourse at 2 or 3 year flood flow. Other physical signs of the bank full width include exposed tree roots, signs of erosion and an abrupt change in the bank slope.

Bed

The land below the ordinary high water lines of provincial waters. This definition does not include irrigation ditches, canals, storm water runoff devices, or artificial watercourses except where they exist in a natural watercourse that has been altered by people.

Bedload

The part of sediment transport not in suspension, consisting of coarse material moving on or near the channel bed.

Channel

A natural or engineered waterway that has definite bed and banks that confine water.

Culvert

A watercourse crossing structure with or without an invert on which rests an embankment that serves as a foundation for the road (in contrast to a bridge, which does not require an embankment). Culverts with an invert may be circular, square, oval, arched or elliptical. Culverts without an invert include both arches and wide culverts on footings (see Figure 28).

Culvert Inlet Invert

The inside bottom elevation at the upstream edge of the culvert.

Culvert Outlet Invert

The inside bottom elevation at the downstream edge of the culvert.

Culvert Slope

The vertical drop from the culvert's inlet invert to the outlet invert divided by the length between these two points. It is usually expressed in percentages or degrees (see Figure 28).

Cut-off Wall

The wall under the culvert inlet and outlet to prevent flow under the culvert and erosion under the pipe.

Debris

Includes natural and foreign materials such as gravel, cobble, rubble, boulder-sized sediments, plastics, metals, rubber, as well as trees and other organic detritus scattered about by either natural processes or human influences.

Dewatering

Removing water from an area.

Downstream Control

The existing streambed thalweg elevation at the first natural undisturbed riffle (or step) located at a distance of three times the culvert diameter plus a minimum of 3.5 m downstream of the proposed culvert outlet (see Figure 28).

Energy Dissipation Pool

The pool located immediately downstream of the culvert that is designed to dissipate the energy of the water flowing through the culvert at high flows and to prevent the erosion of the downstream control. It also provides a resting area for migrating fish. Energy dissipation pools should be constructed at the outlet of all culverts, both non-baffled and baffled. Energy dissipation pools are required for all culverts except embedded culverts.

Erosion

The process of soil and rock weathering caused by natural means (e.g., water, wind, ice, etc.) or by construction-related disturbances (see Figure 29).

Filter Fabric

A natural or synthetic fabric used to block sediment from water flowing through a subsurface or surface area such as through a revetment or through a channel.

Fish

Includes: (a) parts of fish, (b) shellfish, crustaceans, marine animals and any parts of shellfish, crustaceans or marine animals, and (c) the eggs, sperm, spawn, larvae, spat and juvenile stages of fish, shellfish, crustaceans and marine animals.

Fish Habitat

According to the *Fisheries Act*, fish habitat means spawning grounds and any other areas, including nursery, rearing, food supply and migration areas, on which fish depend directly or indirectly in order to carry out their life processes.

Fishway (also known as fish-pass or fish ladder)

Any device, work or other thing that provides for the free passage of fish, including a canal, a fish pump, a fish ladder, a fish elevator and a fish lock.

Hydraulic Jump

Is a phenomenon in the science of hydraulics which is frequently observed in open channel such as rivers and spillways. When liquid at high velocity discharges into a zone of lower velocity, a rather abrupt rise occurs in the liquid surface. The rapidly flowing liquid is abruptly slowed and increases in height, converting some of the flow's initial kinetic energy into an increase in potential energy, with some energy irreversibly lost through turbulence to heat. In an open channel flow, this manifests as the fast flow rapidly slowing and piling up on top of itself similar to how a shockwave forms.

Invert

The lowest point in the internal cross section of an artificial or natural channel.

Manning coefficient

Characterizes the roughness of a flow surface. A smooth surface such as plastic has a low Manning coefficient, while a rough surface has a high Manning coefficient.

Mitigate

Actions to avoid or minimize the impacts to fish resulting from the proposed project activity.

Obstruction

Any slide, dam or other thing impeding wholly or partially the free passage of fish.

Perching

The tendency to develop a falls or cascade at the outfall of a culvert due to erosion of the watercourse channel downstream of the structure. This may limit the ability of the fish to swim upstream of the culvert.

Pool

A deep, slow moving, quiet portion of a watercourse (see Figure 29).

Qualified Person

A biologist or biological technologist with adequate training and knowledge of fisheries management and fish habitat protection to be able to complete a fish habitat evaluation.

Reach

A section of a watercourse having similar physical and biological characteristics.

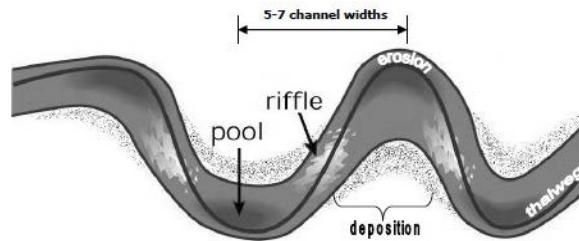

Figure 29. Pool-riffle sequence and erosional and depositional features in meandering watercourses (FISRWG (10/1998). Modified by DFO-FPP March 2014.

Riffle

A section of watercourse in which the water flow is rapid and usually shallower than in sections above and below it. Natural and low-grade watercourses often consist of a succession of pools and riffles (or steps). Riffles act as grade controls for the watercourse. Sometimes riffles are not apparent or are missing. Instead, the grade is controlled by steps. There can be sections of step-pool run interspersed with pool-riffle sections (see Figure 29).

Riparian

The area adjacent to water (e.g., watercourses, perennial or intermittent watercourses, seeps, or springs) that contains elements of both aquatic and terrestrial ecosystems that mutually influence each other.

Riprap

Large, durable materials (usually rocks) used to protect watercourse banks or a lakeshore from erosion.

Scour

Localized erosion caused by flowing water.

Steps

Sometimes riffles are not apparent or are missing. Instead, the grade is controlled by steps. There can be sections of step-pool run interspersed with pool-riffle sections. Steps normally occur as 1 or 3 steps and pools with runs in a 5-to-7 channel section of stream, or 5 steps and pools in the section. These are very common in streams with watersheds under 20 km² and on steep gradients. Steps can be up to 35 cm in height and take up most of the gradient in stream with slopes over 2%. Sometimes sections of step-pool run are interspersed with pool riffle sections.

Substrate

Mineral and organic material that forms the bed of a watercourse.

Tailwater

Waters located immediately downstream from a hydraulic structure, such as a dam (excluding minimum release such as for fish water), bridge or culvert.

Thalweg

The longitudinal line defining the deepest points along the length of a watercourse bed (see Figure 29).

Undermining

The seepage or loss of water under a culvert or other structure.

Upstream Control

The streambed thalweg elevation of the existing watercourse at the proposed culvert inlet invert (see Figure 28).

Watercourse

The bed and shore of every river, stream, lake, creek, pond, lagoon or other natural body of water, and the water therein, within the jurisdiction of the Province.

Watercourse Slope

The vertical drop from the upstream control to the downstream control divided by the length between these two points. It is usually expressed in percentages or degrees (see Figure 28).

Watershed

An area or ridge of land that separates waters flowing to different rivers, basins, or seas.

ACKNOWLEDGEMENTS

Many individuals were consulted in the development of these *Guidelines*. We gratefully acknowledge their interest, collaboration and contributions:

Paul Colson, Nova Scotia Transportation and Infrastructure Renewal
Leanda Delaney, Fisheries and Oceans Canada, Maritimes Region
Andy Dunn, Fisheries and Oceans Canada, Maritimes Region
Kevin Garroway, Nova Scotia Environment
Craig Hominick, Fisheries and Oceans Canada, Maritimes Region
Donald Humphrey, Fisheries and Oceans Canada, Maritimes Region
Carol Jacobi, Fisheries and Oceans Canada, Maritimes Region
George MacNeil, Nova Scotia Transportation and Infrastructure Renewal
Stacey Nurse, Fisheries and Oceans Canada, Maritimes Region
Lisa Paon, Fisheries and Oceans Canada, Maritimes Region
François Plante, Fisheries and Oceans Canada, Gulf Region
Denis Rushton, Stantec
Bob Rutherford, Thaumás Environmental Consultants
Chris Verge, Nova Scotia Transportation and Infrastructure Renewal
Jay Walmsley, Nova Scotia Power

Kathleen Martin

APPENDIX A: FEDERAL LEGISLATION

Fisheries Act

In Canada, most water bodies contain fish or their habitat that are either part of, or support, commercial, recreational or Aboriginal fisheries. Therefore, these water bodies are subject to the prohibition against serious harm to fish.

Proponents are responsible for avoiding and mitigating serious harm to fish that are part of, or support, commercial, recreational or Aboriginal fisheries. When a proponent is unable to completely avoid or mitigate serious harm to fish, it is likely that the project requires authorization under Subsection 35(2) of the *Fisheries Act*. If not, the project is unlikely to proceed without contravening the Act.

Section 35 of the Fisheries Act prohibits “serious harm to fish.” In the act, this is defined as “the death of fish or any permanent alteration to, or destruction of, fish habitat.”

35. (1) No person shall carry on any work, undertaking or activity that results in serious harm to fish that are part of a commercial, recreational or Aboriginal fishery, or to fish that support such a fishery.

Projects that have the potential to obstruct fish passage, modify flow, or projects that result in the entrainment of fish may also cause serious harm to fish. If fish passage cannot be achieved in these situations, authorization under Subsection 35(2) is required.

In addition, Sections 20 and 21 of the *Fisheries Act* require the provision of sufficient water and unimpeded passage for fish. In summary, these provisions:

- allow the Minister to request studies and evaluations related to obstructions or other things that may be hindering fish passage or harming fish
- allow the Minister to request: the removal of or modifications to obstructions or things that are harmful to fish or impede flow or fish passage; the installation of fish-ways, screens and guards; or that sufficient water flow be provided for fish passage
- prohibit the damage or removal of fish-guards, fish-ways, and screens

Species at Risk Act

Proponents are also responsible to ensure that they do not contravene the *Species at Risk Act* (SARA) when conducting work around water. In particular, the following Sections of the SARA are important for culverts:

32. (1) No person shall kill, harm, harass, capture or take an individual of a wildlife species that is listed as an extirpated species, an endangered species or a threatened species.

(2) No person shall possess, collect, buy, sell or trade an individual of a wildlife species that is listed as an extirpated species, an endangered species or a threatened species, or any part or derivative of such an individual.

(3) For the purposes of subsection (2), any animal, plant or thing that is represented to be an individual, or a part or derivative of an individual, of a wildlife species that is listed as an extirpated species, an endangered species or a threatened species is deemed, in the absence of evidence to the contrary, to be such an individual or a part or derivative of such an individual.

33. No person shall damage or destroy the residence of one or more individuals of a wildlife species that is listed as an endangered species or a threatened species, or that is listed as an extirpated species if a recovery strategy has recommended the reintroduction of the species into the wild in Canada.

58. (1) Subject to this section, no person shall destroy any part of the critical habitat of any listed endangered species or of any listed threatened species — or of any listed extirpated species if a recovery strategy has recommended the reintroduction of the species into the wild in Canada — if

(a) the critical habitat is on federal land, in the exclusive economic zone of Canada or on the continental shelf of Canada;

(b) the listed species is an aquatic species; or

(c) the listed species is a species of migratory birds protected by the Migratory Birds Convention Act, 1994.

For general information on aquatic SARA-listed species visit: <http://www.dfo-mpo.gc.ca/species-especes/index-eng.htm>.

APPENDIX B: REGULATORY REVIEW

DFO has arrangements with the Province of Nova Scotia to provide “one window” for project reviews and advice under the fisheries protection provisions of the *Fisheries Act* and the “Activities Designation Regulations” of the *Environment Act*.

If your project takes place in Nova Scotia and you have questions, contact Nova Scotia Environment (NSE) before contacting DFO:

www.novascotia.ca/snsmr/paal/nse/paal181.asp

However, if your inquiry relates specifically to fish passage or the *Fisheries Act*, then contact DFO:

www.dfo-mpo.gc.ca/pnw-ppe/contact-eng.html

NSE notification process

DFO and NSE have streamlined certain low-risk projects that will require a formal notification to NSE and must be carried out in accordance with the *Nova Scotia Watercourse Alterations Standards*. The notification requires the proponent to fill out a form describing the project, identifying the: proponent, trained installer, trained designer, sizer and engineer. The location of the project must be provided including GPS coordinates as well as details of the watercourse including its slope. An example of an activity requiring notification would be the installation of a culvert measuring less than 25 m where the watercourse slope does not exceed 0.5% and the work is undertaken between June 1st and September 30th.

DFO and/or NSE may monitor these projects at any stage to ensure compliance with the *Environment Act* and the *Fisheries Act*.

A notification receipt must be obtained from Nova Scotia Environment prior to the commencement of the proposed activity.

NSE standard approvals with DFO review

For projects that do not fall within the streamlined notification process (i.e. retrofitting existing culverts, culverts installed in a watercourse where slope exceeds 8%) a standard application should be sent to NSE, which will then be forwarded to DFO for review. To ensure a timely review, the application should be complete, accurate and include all of the information outlined below.

- 1. Description of Project**
- 2. Location of project, including**
 - a. Map(s), site plan or diagrams indicating
 - i. High water mark
 - ii. Location, size and nature of proposed and existing structures
 - iii. Proposed activities
 - b. Clear directions to the site with GPS Coordinates
- 3. Details about the construction methods to be used, including**
 - a. Timing of the works
 - b. Building materials to be used (if using concrete, indicate if pre-cast or cast-in-place)
 - c. Machinery and equipment to be used
 - d. Water control plan, clearing, excavation, grading

4. Drawings of proposed works (e.g. bridges, culverts, arches) which should illustrate

- a. Instream footprint below high water mark (including scour protection)
- b. Proposed crossing location along watercourse
- c. Alignment of crossing to natural watercourse
- d. Existing structure
- e. Proposed structure (i.e. length, diameter, width)
- f. Any proposed temporary works below the high watermark
- g. Re-vegetation plans

5. Description of the aquatic environment

- a. Name of water body
- b. Total drainage area immediately above the crossing location
- c. Type of water body (river, lake, marine, estuary, etc.)
- d. Source of watercourse (groundwater, river, lake)
- e. Type of flow (permanent or intermittent; controlled or natural)
- f. Identify average depth and bank full width of watercourse in spring or fall (during moderate flow)
- g. Substrate characterization - describe the types and percentage of substrate (e.g., 80% cobble, 20% gravel, etc.)
- h. Presence/absence of aquatic vegetation
- i. Type of riparian vegetation (e.g., trees, shrubs, grass)
- j. Identify fish species known or suspected to be in the area. How was this information obtained?

The spatial scope for assessing fish and fish habitat should encompass the direct physical footprint of the project below the high water mark, and the upstream and downstream areas affected by the proposed project.

6. Project Impacts

- a. Direct physical "footprint" of the proposed project and any areas indirectly affected, such as downstream or upstream areas or the riparian zone, including any temporary works such as earthen berms, culvert crossings, infills, etc.

7. Photos

- a. Looking upstream and downstream of the proposed crossing site
- b. Upstream end of existing crossing, if applicable
- c. Downstream end of existing crossing, if applicable
- d. Substrate in the vicinity of the crossing
- e. Natural barriers to fish passage, if applicable

Additional information required for culvert crossings (including arch structures and embedded):

- Watercourse slope at crossing
- Slope of existing crossing (if applicable)
- Slope of proposed crossing

- Elevations at:
 - Upstream control point (thalweg at upstream end of the first natural riffle above crossing)
 - Inlet invert of the proposed crossing
 - Outlet invert of the proposed crossing
 - Downstream control point (thalweg at upstream end of the first natural riffle below crossing)
 - Top of most upstream baffle, if applicable
 - Top of most downstream baffle, if applicable
- Spacing between baffles, if applicable
- Energy dissipation pool (i.e. length, width, depth, construction material)

Additional information required for retrofitting culverts with instream weir installation

- Provide the site survey information as per the site characterization and field survey section of these *Guidelines*
- Water control plan

DFO Authorization Requirements

If your project is likely to result in serious harm to fish that are part of, or support, commercial, recreational or Aboriginal fisheries, an Authorization under Section 35 of the *Fisheries Act* will likely be required. DFO will inform the proponent directly if this is the case and will request any additional information, including an offsetting plan.

APPENDIX C: PROVINCIAL LEGISLATION

Environment Act

In Nova Scotia the watercourse alteration approval process is regulated by the *Activities Designation Regulations* pursuant to the *Nova Scotia Environment Act* (1995). In particular, Section 5 of the *Activities Designation Regulations* applies.

5 (2) The use or alteration of a watercourse for one or more of the following purposes is an activity that requires notification and must be carried out in accordance with the Nova Scotia Watercourse Alterations Standards:

- a) *The construction or modification of a single culvert or other single closed bottom structure for the purpose of a road, railbed, trail or footpath crossing if:*
 - (i) *The length of the culvert is 25 metres or less;*
 - (ii) *The watercourse slope does not exceed 0.5%;*
 - (iii) *The drainage area up-gradient of the watercourse crossing does not exceed 20 km²;*
 - (iv) *The work is completed between June 1 and September 30 of any given year; and*
 - (v) *The design of the structure is prepared by a person holding a valid and subsisting Watercourse Alteration Certificate for Sizers; or*
 - (vi) *The design of the structure is prepared by a person holding a valid and subsisting certificate of registration or licensed to practice under the Engineering Profession Act.*

- b) *The construction or modification of a single culvert or other single closed bottom structure for the purpose of a road, railbed, trail or footpath crossing if:*
 - (i) *The watercourse slope is greater than 0.5% but not more than 8.0%;*
 - (ii) *The length of the culvert is 25 metres or less;*
 - (iii) *The minimum culvert size is 1200mm in diameter;*
 - (iv) *The drainage area up-gradient of the watercourse crossing does not exceed 20 km²;*
 - (v) *The design must be in accordance with current DFO standards;*
 - (vi) *The work is completed between June 1 and September 30 of any given year; and*
 - (vii) *The design of the structure is prepared by a person holding a valid and subsisting certificate of registration or licensed to practice under the Engineering Profession Act.*

Note: Effective October 1, 2016 the above activities must be carried out by a Watercourse Alteration Installer or under the direct supervision of a Watercourse Alteration Installer.

APPENDIX D: GUIDELINE APPLICABILITY

The following chart provides the designer with options for choosing a watercourse crossing structure based on site-specific parameters. For this document the recommendation for a minimum culvert size in a fish-bearing watercourse is 750 mm. The recommendation for a minimum culvert size with baffles installed is 1200 mm.

Note: Although not listed here, most fish passage problems can be avoided by using a clear span bridge structure or an open-bottom structure. These structures maintain the natural bed and bank formation of the watercourse. Bridges or properly designed open-bottom structures allow unrestricted movement of the bedload by maintaining the natural stream bottom.

Embedded culverts

If the constraints of the site do not allow for a baffled or non-baffled culvert and the proponent chooses an embedded culvert, please be aware that this requires a standard application/approval. Note that the minimum diameter for embedded culverts in this guideline is 4 000 mm and the maximum watercourse slope is 3%. There may be other design options that fall outside this guideline that can be proposed and reviewed on a case-by-case basis.

Culvert Diameter	Culvert Length	Drops between baffles	Watercourse slope	Non- baffled culvert; follow guideline	Baffled culvert; follow guideline
750 mm	5 m	n/a	≤ 0.5 %	Yes	n/a
	10 m	n/a	≤ 0.5 %	Yes	n/a
	15 m	n/a	≤ 0.5 %	Yes	n/a
	20 m	n/a	≤ 0.4 %	Yes	n/a
	25 m	n/a	≤ 0.4 %	Yes	n/a
900 mm	5 m	n/a	≤ 0.5 %	Yes	n/a
	10 m	n/a	≤ 0.5 %	Yes	n/a
	15 m	n/a	≤ 0.5 %	Yes	n/a
	20 m	n/a	≤ 0.4 %	Yes	n/a
	25 m	n/a	≤ 0.4 %	Yes	n/a
1200 mm	5 m	n/a	≤ 0.5 %	Yes	n/a

Culvert Diameter	Culvert Length	Drops between baffles	Watercourse slope	Non- baffled culvert; follow guideline	Baffled culvert; follow guideline
	10 m	n/a	≤ 0.5 %	Yes	n/a
		150 mm	> 0.5 - ≤ 1.5 %	n/a	Yes
		200 mm	> 0.5 - ≤ 3	n/a	Yes
		n/a	> 3 %	n/a	n/a
	15 m	n/a	≤ 0.5 %	Yes	n/a
		150 mm	> 0.5 - ≤ 3.5 %	n/a	Yes
		200 mm	> 0.5 - ≤ 5 %	n/a	Yes
		n/a	> 5 %	n/a	n/a
	20 m	n/a	≤ 0.4 %	Yes	n/a
		150 mm	> 0.5 - ≤ 4.5 %	n/a	Yes
		200 mm	> 0.5 - ≤ 6 %	n/a	Yes
		n/a	> 6 %	n/a	n/a
	25 m	n/a	≤ 0.4 %	Yes	n/a
		150 mm	> 0.5 - ≤ 5.5 %	n/a	Yes
		200 mm	> 0.5 - ≤ 7.5 %	n/a	Yes
		n/a	> 7.5 %	n/a	n/a
	> 25 m	-----	< 8%	n/a	Yes, with a site specific design
1500 mm	5 m	n/a	≤ 0.5 %	Yes	n/a
	10 m	n/a	≤ 0.5 %	Yes	n/a
		150 mm	> 0.5 - ≤ 1.5 %	n/a	Yes
		200 mm	> 0.5 - ≤ 3 %	n/a	Yes
		n/a	> 3 %	n/a	n/a
	15 m	n/a	≤ 0.5 %	Yes	n/a
		150 mm	> 0.5 - ≤ 3.5 %	n/a	Yes
		200 mm	> 0.5 - ≤ 5 %	n/a	Yes

Culvert Diameter	Culvert Length	Drops between baffles	Watercourse slope	Non- baffled culvert; follow guideline	Baffled culvert; follow guideline
		n/a	> 5 %	n/a	n/a
	20 m	n/a	≤ 0.5 %	Yes	n/a
		150 mm	> 0.5 - ≤ 4.5 %	n/a	Yes
		200 mm	> 0.5 - ≤ 6.5 %	n/a	Yes
		n/a	> 6.5 %	n/a	n/a
	25 m	n/a	≤ 0.4 %	Yes	n/a
		150 mm	> 0.5 - ≤ 5.5 %	n/a	Yes
		200 mm	> 0.5 - ≤ 7.5 %	n/a	Yes
		n/a	> 7.5 %	n/a	n/a
	> 25 m	-----	< 8%	n/a	Yes, with a site specific design
1800 mm	5 m	n/a	≤ 0.5 %	Yes	n/a
	10 m	n/a	≤ 0.5 %	Yes	n/a
		150 mm	> 0.5 - ≤ 1.5 %	n/a	Yes
		200 mm	> 0.5 - ≤ 3 %	n/a	Yes
		n/a	> 3 %	n/a	n/a
	15 m	n/a	≤ 0.5 %	Yes	n/a
		150 mm	> 0.5 - ≤ 3 %	n/a	Yes
		200 mm	> 0.5 - ≤ 5 %	n/a	Yes
		n/a	> 5 %	n/a	n/a
	20 m	n/a	≤ 0.5 %	Yes	n/a
		150 mm	> 0.5 - ≤ 4 %	n/a	Yes
		200 mm	> 0.5 - ≤ 6.5 %	n/a	Yes
		n/a	> 6.5 %	n/a	n/a
	25 m	n/a	≤ 0.5 %	Yes	n/a
		150 mm	> 0.5 - ≤ 5 %	n/a	Yes

Culvert Diameter	Culvert Length	Drops between baffles	Watercourse slope	Non- baffled culvert; follow guideline	Baffled culvert; follow guideline
		200 mm	> 0.5 - ≤7 %	n/a	Yes
		n/a	> 7 %	n/a	n/a
	> 25 m	-----	< 8%	n/a	Yes, with a site specific design
2100 mm	5 m	n/a	≤ 0.5 %	Yes	n/a
	10 m	n/a	≤ 0.5 %	Yes	n/a
		150 mm	> 0.5 - ≤ 1.5 %	n/a	Yes
		200 mm	> 0.5 - ≤ 3 %	n/a	Yes
		n/a	> 3 %	n/a	n/a
	15 m	n/a	≤ 0.5 %	Yes	n/a
		150 mm	> 0.5 - ≤ 3 %	n/a	Yes
		200 mm	> 0.5 - ≤ 5 %	n/a	Yes
		n/a	> 5 %	n/a	n/a
	20 m	n/a	≤ 0.5 %	Yes	n/a
		150 mm	> 0.5 - ≤ 4 %	n/a	Yes
		200 mm	> 0.5 - ≤ 6 %	n/a	Yes
		n/a	> 6 %	n/a	n/a
	25 m	n/a	≤ 0.5 %	Yes	n/a
		150 mm	> 0.5 - ≤ 5 %	n/a	Yes
		200 mm	> 0.5 - ≤7 %	n/a	Yes
		n/a	> 7 %	n/a	n/a
	> 25 m	-----	< 8%	n/a	Yes, with a site specific design
2400 mm	5 m	n/a	≤ 0.5 %	Yes	n/a
	10 m	n/a	≤ 0.5 %	Yes	n/a
		150 mm	> 0.5 - ≤ 1.5 %	n/a	Yes

Culvert Diameter	Culvert Length	Drops between baffles	Watercourse slope	Non- baffled culvert; follow guideline	Baffled culvert; follow guideline
		200 mm	> 0.5 - ≤ 2.5 %	n/a	Yes
		n/a	> 2.5 %	n/a	n/a
	15 m	n/a	≤ 0.5 %	Yes	n/a
		150 mm	> 0.5 - ≤ 3 %	n/a	Yes
		200 mm	> 0.5 - ≤ 4.5 %	n/a	Yes
		n/a	> 4.5 %	n/a	n/a
	20 m	n/a	≤ 0.5 %	Yes	n/a
		150 mm	> 0.5 - ≤ 4 %	n/a	Yes
		200 mm	> 0.5 - ≤ 6 %	n/a	Yes
		n/a	> 6 %	n/a	n/a
	25 m	n/a	≤ 0.5 %	Yes	n/a
		150 mm	> 0.5 - ≤ 5.5 %	n/a	Yes
		200 mm	> 0.5 - ≤ 7 %	n/a	Yes
		n/a	> 7 %	n/a	n/a
	> 25 m	-----	< 8%	n/a	Yes, with a site specific design
3000 mm	5 m	n/a	≤ 0.5 %	Yes	n/a
	10 m	n/a	≤ 0.5 %	Yes	n/a
		150 mm	> 0.5 - ≤ 1.5 %	n/a	Yes
		200 mm	> 0.5 - ≤ 2.5 %	n/a	Yes
		n/a	> 2.5 %	n/a	n/a
	15 m	n/a	≤ 0.5 %	Yes	n/a
		150 mm	> 0.5 - ≤ 2.5 %	n/a	Yes
		200 mm	> 0.5 - ≤ 4 %	n/a	Yes
		n/a	> 4 %	n/a	n/a
	20 m	n/a	≤ 0.5 %	Yes	n/a

Culvert Diameter	Culvert Length	Drops between baffles	Watercourse slope	Non- baffled culvert; follow guideline	Baffled culvert; follow guideline
		150 mm	> 0.5 - ≤ 3.5 %	n/a	Yes
		200 mm	> 0.5 - ≤ 5.5 %	n/a	Yes
		n/a	> 5.5 %	n/a	n/a
	25 m	n/a	≤ 0.5 %	Yes	n/a
		150 mm	> 0.5 - ≤ 4.5 %	n/a	Yes
		200 mm	> 0.5 - ≤ 6 %	n/a	Yes
		n/a	> 6 %	n/a	n/a
	> 25 m	-----	< 8%	n/a	Yes, with a site specific design
3600	5 m	n/a	≤ 0.5 %	Yes	n/a
	10 m	n/a	≤ 0.5 %	Yes	n/a
		150 mm	> 0.5 - ≤ 1 %	n/a	Yes
		200 mm	> 0.5 - ≤ 2.5 %	n/a	Yes
		n/a	> 2.5 %	n/a	n/a
	15 m	n/a	≤ 0.5 %	Yes	n/a
		150 mm	> 0.5 - ≤ 2.5 %	n/a	Yes
		200 mm	> 0.5 - ≤ 4 %	n/a	Yes
		n/a	> 4 %	n/a	n/a
	20 m	n/a	≤ 0.5 %	Yes	n/a
		150 mm	> 0.5 - ≤ 3.5 %	n/a	Yes
		200 mm	> 0.5 - ≤ 5 %	n/a	Yes
		n/a	> 5 %	n/a	n/a
	25 m	n/a	≤ 0.4 %	Yes	n/a
		150 mm	> 0.5 - ≤ 4 %	n/a	Yes
		200 mm	> 0.5 - ≤ 6 %	n/a	Yes
		n/a	> 6 %	n/a	n/a

Culvert Diameter	Culvert Length	Drops between baffles	Watercourse slope	Non- baffled culvert; follow guideline	Baffled culvert; follow guideline
	> 25 m	-----	< 8%	n/a	Yes, with a site specific design

APPENDIX E: NOVA SCOTIA FISH SPECIES REQUIRING FISH PASSAGE

FISH SPECIES	SELECTION OF CRITERIA FOR FISH PASSAGE		COMMENTS
	Commercial/Recreational/Aboriginal	SARA	
Alewife or Gaspereau (<i>Alosa pseudoharengus</i>)	Yes		
American eel (<i>Anguilla rostrata</i>)	Yes		
American shad (<i>Alosa sapidissima</i>)	Yes		
Atlantic salmon (<i>Salmo salar</i>) (Including land-locked populations)	Yes	Yes, IBoF	Inner Bay of Fundy population - Endangered Species.
Atlantic tomcod (<i>Microgadus tomcod</i>)	Yes		
Atlantic (Acadian) whitefish (<i>Coregonus huntsmani</i>)	Yes	Yes	Endangered Species, Restricted range.
Blueback herring (<i>Alosa aestivalis</i>) see Alewife	Yes		
Brook trout (<i>Salvelinus fontinalis</i>)	Yes		
Brown trout (<i>Salmo trutta</i>)	Yes		
Chain pickerel (<i>Esox niger</i>)	Yes		Aquatic Invasive Species, see note below.
Lake trout (<i>Salvelinus namaycush</i>)	Yes		
Lake Whitefish (<i>Coregonus clupeaformis</i>)	Yes		

FISH SPECIES	SELECTION OF CRITERIA FOR FISH PASSAGE		COMMENTS
	Commercial/Recreational/Aboriginal	SARA	
Rainbow smelt (<i>Osmerus mordax</i>)	Yes		
Rainbow trout (<i>Oncorhynchus mykiss</i>)	Yes		
Sea lamprey (<i>Petromyzon marinus</i>)	Yes		
Smallmouth bass (<i>Micropterus dolomieu</i>)	Yes		Aquatic Invasive Species, see note below.
Striped bass (<i>Morone saxatilis</i>)	Yes		
White perch (<i>Morone americana</i>)	Yes		
White sucker (<i>Catostomus commersoni</i>)	Yes		
Yellow perch (<i>Perca flavescens</i>)	Yes		

Note:

For invasive species such as Chain pickerel and Smallmouth bass they may be a threat to other fisheries; therefore, if these species are known to be present at your site, contact DFO-FPP for consultation prior to making a determination on fish passage.

APPENDIX F: FISH RESCUE GUIDELINES

Fish rescues must be performed whenever instream work could harm fish, for example, during required in-water work for culvert or bridge installations. Fish rescues should have a site-specific rescue plan on site and its conditions must be followed. All fish rescues must be conducted in accordance with the *Fisheries Act*, and the *Species at Risk Act (SARA)* and related regulations and recovery plans (see Appendix A). A license to collect and move the fish must be obtained from DFO prior to any fish rescue. This license must be on site.

Please contact DFO through the National Online Licensing System at <http://www.dfo-mpo.gc.ca/index-eng.htm>.

In addition, there may be a requirement for a SARA section 73 permit (e.g., if the work could harm an aquatic endangered or threatened species). In this case, please email XMARSARA@dfo-mpo.gc.ca for the Maritimes Region or GLF-SARA-LEP@dfo-mpo.gc.ca for the Gulf Region.

Fish rescues must take place before the commencement of any instream work and within the allowable time frame specified in the DFO license.

The following guidelines were prepared by the Nova Scotia Salmon Association (NSSA) with DFO comment and review.

Electrofishing method

The preferred method of fish rescue in flowing freshwater watercourses is by electrofishing.

- The rescue area has to be isolated from the rest of the watercourse to prevent fish from re-entering.
- The fish rescue must be done before or in conjunction with the start of any water diversion.
- Watercourses deeper than 60cm may be coffer dammed and the water partially diverted or pumped to allow for an effective fish rescue. If this is not possible, a seine net can be used to capture fish, followed by electrofishing when the water level is lowered.
- Electrofishing can be conducted in an upstream to downstream, or downstream to upstream direction, as deemed practical by the electrofishing crew.
- Electrofishing rescues should not proceed when water temperatures are above 22°C or below 7°C unless specifically approved by DFO.

- Electrofishing passes should be complete, covering the entire wetted area of the watercourse.
- During water draw down the rescue area will be checked to remove any fish species not collected during the initial electrofishing passes.
- Captured fish should be retained in a container of minimum 30L volume filled with clean water taken from the stream. The retention bucket temperature should not exceed 22°C and not vary from the stream temperature by more than 2°C.
- To maintain sufficient oxygen levels in the container, the container water must be refreshed or changed as necessary.
- Fish should not be overcrowded in the container and the container should be emptied as necessary to prevent stressing of fish.
- Handling of fish should be minimal. Normally just from the dip net into the bucket. If handling is needed, use only clean and wet bare hands to avoid excessive removal of the mucilaginous layer. Improper handling of fish may result in the removal of the mucilaginous layer, oxygen deprivation, and general stress or death of the fish.
- No anesthetic should be used on the fish.
- Fish must be released in the same watercourse of capture and immediately upstream or downstream of the rescue area. If the water is being pumped around the site or fish passage past the site is not otherwise available migrating adult fish should be released upstream of the rescue area, and non-migrating fish should be released downstream of the rescue area.
- Any mortality should be released into the watercourse, downstream of the rescue area, and reported to DFO.
- During summer months when peak air temperatures are high (i.e. above 25°C) electrofishing rescues should be conducted during morning hours.
- When all work in or around the watercourse has finished, barriers or coffer dams must be completely removed.
- Rescue reports must be forwarded to DFO and include all information requested in the fishing license.

Barrier net method

- Barrier nets should be placed upstream and downstream of the work area which includes the pump intake location.

- Netting used for barriers should be maximum ½ inch stretch mesh and be of sufficient length and width so as to reach fully from bank to bank and to prevent over-topping during any high flow.
- Barrier nets should be doubled and held in place with sufficiently-sized substrate or a row of pea stone-filled bags along the stream bottom. The seal along the bottom and banks of the stream must be complete to prevent re-entry of fish into the rescue area.
- All nets must be labeled with a DFO license number and contact information of the license holder.
- Nets must be regularly monitored and cleaned of debris as necessary to prevent clogging and restriction of water flow.

Coffer dam method

- If the water is to be diverted around the site, not pumped, then the work area can be isolated using coffer dams.
- Sandbags filled with pea stone and plastic sheeting can be used for a coffer dam or sheet pile wall.
- Prior to fully diverting the watercourse around the work site, the upstream coffer dam should be partially built. Sufficient flow over the upstream cofferdam should be maintained to provide suitable water depths for electrofishing.
- All fish removed should be released immediately downstream of the work site.
- When the fish rescue is complete the coffer dams can be closed off and the remaining water pumped out.
- Any plastic and sandbags used for the construction of coffer dams must be of sufficient strength to avoid tearing, and/or breakdown or release into the watercourse.
- Other coffer damming techniques are also acceptable.

APPENDIX G: CULVERT SITE DESIGN FLOW

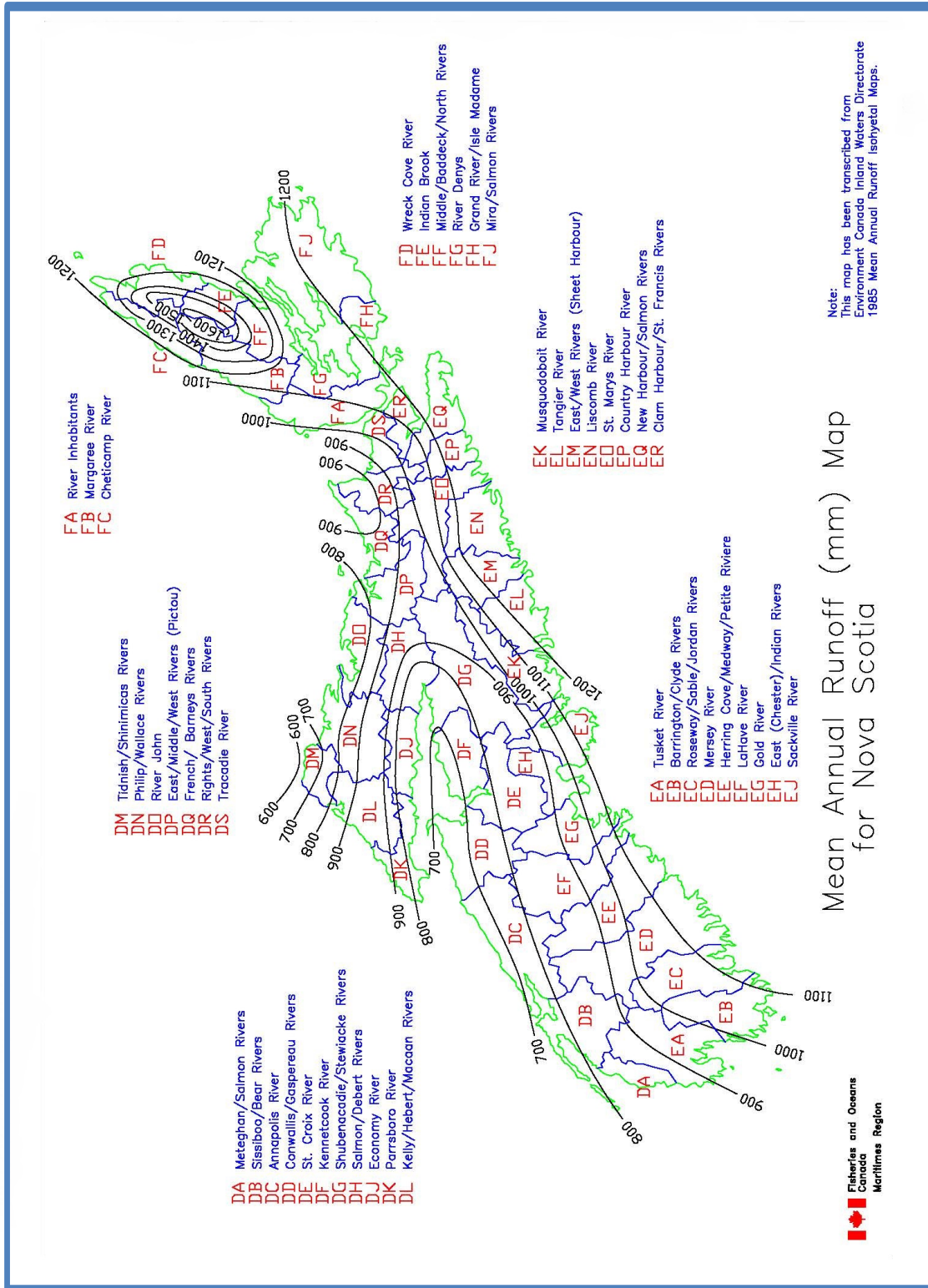

June Q60 Design Flow for Culvert Sites located in Nova Scotia Primary Watersheds:

- DA** Meteghan/Salmon Rivers
- DB** Sissiboo/Bear Rivers
- DC** Annapolis River
- DD** Cornwallis/Gaspereau Rivers
- DE** St. Croix River
- DF** Kennetcook River
- DG** Shubenacadie/Stewiacke Rivers

Benchmark Values:	mean annual runoff (mar)	=	725 mm
	drainage area (da)	=	12.3 km ²
	june q60	=	0.145 m ³ /s

1) Determine the Mean Annual Runoff value for the culvert site:
 (Locate value from the Mean Annual Runoff Map)
 Site Mean Annual Runoff (MAR) = _____ mm

2) Determine the watershed Drainage Area value for the culvert site:
 Site Drainage Area (DA) = _____ km²

3) Prorate the required Culvert Site Design Flows from the Benchmark Values:
JUNE Q60 = june q60 x MAR/mar x DA/da = _____ m³/s

Note: Benchmark Values were averaged from Gauging Stations: 01DD004
 01DD005

June Q60 Design Flow for Culvert Sites located in Nova Scotia Primary Watersheds:

DH	Salmon/Debert Rivers	DO	River John
DJ	Economy River	DP	East/Middle/West Rivers (Pictou)
DK	Parrsboro River	DQ	French/Barneys Rivers
DL	Kelly/Hebert/Maccan Rivers	DR	Rights/West/South Rivers
DM	Tidnish/Shinimicas Rivers	DS	Tracadie River
DN	Philip/Wallace Rivers		

Benchmark Values:	mean annual runoff (mar)	=	975 mm
	drainage area (da)	=	29.1 km ²
	june q60	=	0.280 m ³ /s

1) Determine the Mean Annual Runoff value for the culvert site:
 (Locate value from the Mean Annual Runoff Map)
 Site Mean Annual Runoff (MAR) = _____ mm

2) Determine the watershed Drainage Area value for the culvert site:
 Site Drainage Area (DA) = _____ km²

3) Prorate the required Culvert Site Design Flows from the Benchmark Values:
JUNE Q60 = june q60 x MAR/mar x DA/da = _____ m³/s

Note: Benchmark Values were averaged from Gauging Stations: 01DH003
 01DL001
 01FG001

June Q60 Design Flow for Culvert Sites located in Nova Scotia Primary Watersheds:

- EA** Tusket River
- EB** Barrington/Clyde Rivers
- EC** Roseway/Sable/Jordan Rivers
- ED** Mersey River
- EE** Herring Cove/Medway/Petite Riviere
- EF** LaHave River
- EG** Gold River

Benchmark Values:	mean annual runoff (mar)	=	875 mm
	drainage area (da)	=	17.7 km ²
	june q60	=	0.114 m ³ /s

1) Determine the Mean Annual Runoff value for the culvert site:
 (Locate value from the Mean Annual Runoff Map)
 Site Mean Annual Runoff (MAR) = _____ mm

2) Determine the watershed Drainage Area value for the culvert site:
 Site Drainage Area (DA) = _____ km²

3) Prorate the required Culvert Site Design Flows from the Benchmark Values:
JUNE Q60 = june q60 x MAR/mar x DA/da = _____ m³/s

Note: Benchmark Values were taken from Gauging Station: 01EE005

June Q60 Design Flow for Culvert Sites located in Nova Scotia Primary Watersheds:

- EH** East (Chester)/Indian Rivers
- EJ** Sackville River
- EK** Musquodoboit River

Benchmark Values:	mean annual runoff (mar)	=	900 mm
	drainage area (da)	=	13.1 km ²
	june q60	=	0.070 m ³ /s

1) Determine the Mean Annual Runoff value for the culvert site:
 (Locate value from the Mean Annual Runoff Map)
 Site Mean Annual Runoff (MAR) = _____ mm

2) Determine the watershed Drainage Area value for the culvert site:
 Site Drainage Area (DA) = _____ km²

3) Prorate the required Culvert Site Design Flows from the Benchmark Values:
JUNE Q60 = june q60 x MAR/mar x DA/da = _____ m³/s

Note: Benchmark Values were taken from Gauging Station: 01EJ004

June Q60 Design Flow for Culvert Sites located in Nova Scotia Primary Watersheds:

- EL** Tangier River
- EM** East/West Rivers (Sheet Harbour)
- EN** Liscomb River
- EO** St. Marys River
- EP** Country Harbour River
- EQ** New Harbour/Salmon Rivers
- ER** Clam Harbour/St. Francis Rivers

Benchmark Values:	mean annual runoff (mar)	=	1025 mm
	drainage area (da)	=	29.1 km ²
	june q60	=	0.195 m ³ /s

- 1) Determine the Mean Annual Runoff value for the culvert site:
 (Locate value from the Mean Annual Runoff Map)
 Site Mean Annual Runoff (MAR) = _____ mm

- 2) Determine the watershed Drainage Area value for the culvert site:
 Site Drainage Area (DA) = _____ km²

- 3) Prorate the required Culvert Site Design Flows from the Benchmark Values:

$$\mathbf{JUNE\ Q60} = \text{june q60} \times \text{MAR}/\text{mar} \times \text{DA}/\text{da} = \underline{\hspace{2cm}} \text{ m}^3/\text{s}$$

Note: Benchmark Values were averaged from Gauging Stations: 01EJ004
 01ER001

June Q60 Design Flow for Culvert Sites located in Nova Scotia Primary Watersheds:

- FA** River Inhabitants
- FB** Margaree River
- FC** Cheticamp River
- FD** Wreck Cove River
- FE** Indian Brook
- FF** Middle/Baddeck/North Rivers
- FG** River Denys

Benchmark Values:	mean annual runoff (mar)	=	1150 mm
	drainage area (da)	=	10.1 km ²
	june q60	=	0.205 m ³ /s

1) Determine the Mean Annual Runoff value for the culvert site:
 (Locate value from the Mean Annual Runoff Map)
 Site Mean Annual Runoff (MAR) = _____ mm

2) Determine the watershed Drainage Area value for the culvert site:
 Site Drainage Area (DA) = _____ km²

3) Prorate the required Culvert Site Design Flows from the Benchmark Values:
JUNE Q60 = june q60 x MAR/mar x DA/da = _____ m³/s

Note: Benchmark Values were averaged from Gauging Stations: 01FB005
 01FG001

June Q60 Design Flow for Culvert Sites located in Nova Scotia Primary Watershed:

FH Grand River/Isle Madame
FJ Mira/Salmon Rivers

Benchmark Values: mean annual runoff (mar) = 1200 mm
 drainage area (da) = 17.2 km²
 june q60 = 0.110 m³/s

1) Determine the Mean Annual Runoff value for the culvert site:
 (Locate value from the Mean Annual Runoff Map)
 Site Mean Annual Runoff (MAR) = _____ mm

2) Determine the watershed Drainage Area value for the culvert site:
 Site Drainage Area (DA) = _____ km²

3) Prorate the required Culvert Site Design Flows from the Benchmark Values:
JUNE Q60 = june q60 x MAR/mar x DA/da = _____ m³/s

Note: Benchmark Values were taken from Gauging Station: 01FJ002

APPENDIX H: CULVERT DESIGN EXAMPLES

Example 1

The culvert is to be 30 m long and is to accommodate the June Q60 flow of 0.066 m³/s. It is a round concrete culvert with a 1.5 m diameter and each section is 2.44 m in length.

Note: There is smelt in the watercourse.

The lowest baffle will be at 1.22m from the end of the culvert. The culvert will be installed between station 0-015 and 0+015.

The following survey information is available:

Station	Streambed Elevation (m)
0-075	92.312
0-066	91.822
0-057	92.122
0-050	91.602
0-043	91.772
0-032	91.112
0-020	91.162
0-015	91.102
0+000	90.780
0+015	90.593
0+025	90.043
0+035	90.243
0+059	90.000
0+086	90.145
0+115	89.673

Determine the watercourse slope and if baffles are needed

The culvert diameter is 1.5 m, 3 times the culvert diameter plus 3.5 m equals 8 m. According to the survey information, the first downstream control riffle beyond 8 m from the culvert is located at station 0+035 and the proposed inlet invert and upstream control of the culvert is located at station 0-015.

The watercourse slope between the two stations is

$$((91.102-90.243)/55)*100 = 1.72\%$$

Therefore, **baffles are needed.**

Fish Passage Design

Step 1: Determine the culvert inlet and outlet invert elevations

Verify the lowest baffle location from the end of the culvert outlet.

$$1.22 \text{ m} < 1.25 \text{ m OK}$$

As determined above the first downstream control riffle beyond 8 m from the culvert is at station 0+035 and the elevation is 90.243 m.

The baffle top of the lowest baffle will also be at elevation 90.243 m. The invert of the culvert under this baffle will be:

$$90.243 \text{ m} - 0.5 \text{ m (baffle depth)} = 89.743 \text{ m}$$

The upstream culvert inlet invert elevation at station 0-015 is 91.102 m

The slope of the culvert will be:

$$((91.102-89.743)/30-1.22)*100 = 4.72\%$$

The downstream culvert outlet invert elevation at station 0+015 will be:

$$89.743 - (4.72\% * 1.22\text{m}) = 89.685 \text{ m}$$

Step 2: Determine the dimensions of the energy dissipation pool

The width of the pool will be two times the diameter of the culvert:

$$2D = 3 \text{ m}$$

The length of the pool will be three times the diameter of the culvert plus a minimum of 3.5 m:

$$3D + 3.5\text{m} = 8 \text{ m}$$

The pool depth will be at least 1 m.

The pool outlet invert will be at elevation 90.243 m

Step 3: Determine the baffles notch size

With a June Q60 flow of 0.066 m³/s, we look at Table 2 and determine that the following dimensions are needed:

Notch width.....300 mm
Notch depth.....250 mm
Baffle height.....500 mm

Step 4: Determine the baffle spacing

Maximum possible baffle spacing

$$I = \Delta h / \text{culvert slope}$$

$$I = 0.150\text{m} / 4.72\% = 3.178 \text{ m}$$

In order to simplify the manufacturer's task and the installation in the field we will install the baffles at every 2.44 m. The difference of elevation between each baffle will now be 0.115 m.

The baffles will be located as follows. See also the drawing on the following page.

Baffle #	Station	Notch Sill Elevation (m)
1	0+013.78	89.993
2	0+011.34	90.108
3	0+008.90	90.223
4	0+006.46	90.338
5	0+004.02	90.453
6	0+001.58	90.568
7	0-000.86	90.683
8	0-003.30	90.798
9	0-005.74	90.913
10	0-008.18	91.028
11	0-010.62	91.143
12	0-013.06	91.258

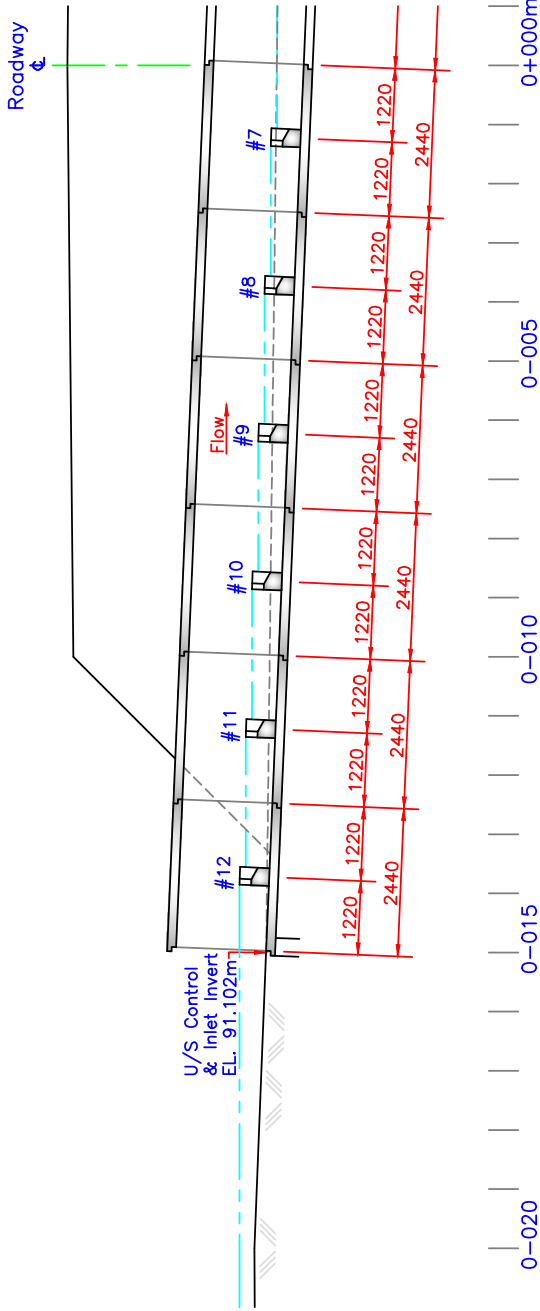

NOTE

1. All dimensions are in millimeters unless otherwise noted.

CULVERT PROFILE SECTION UPSTREAM OF ROADWAY CENTERLINE

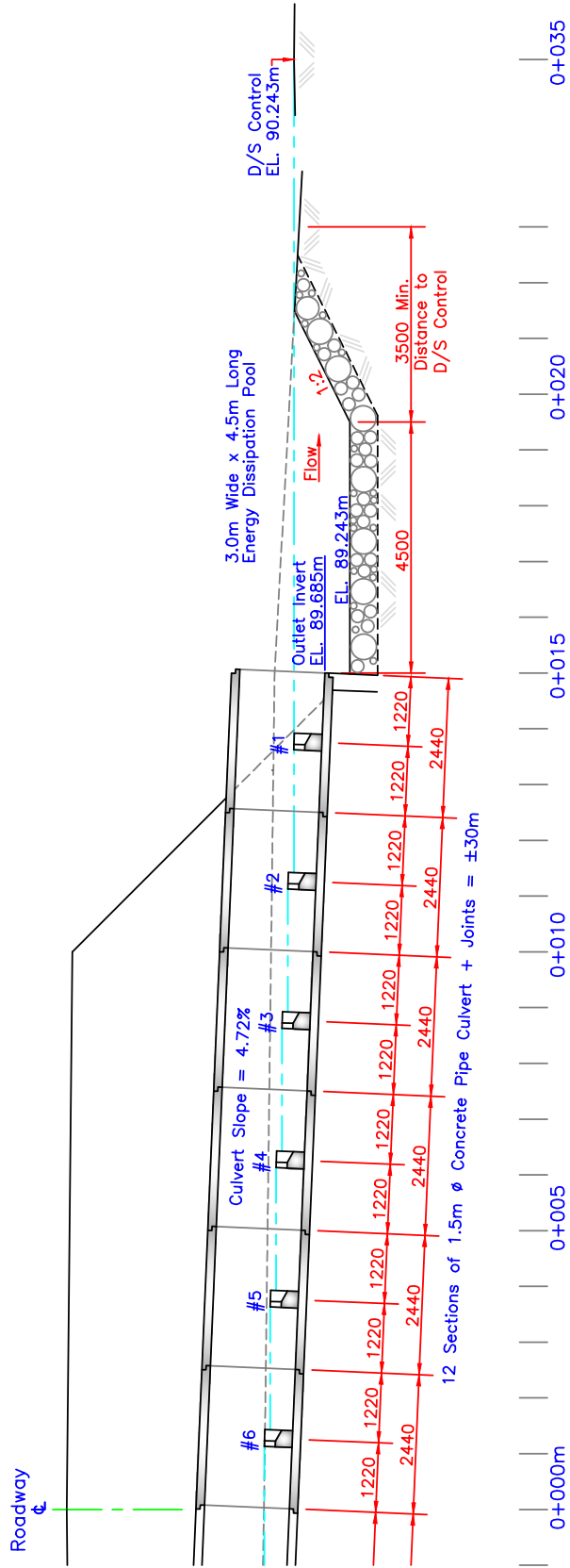

CULVERT PROFILE SECTION DOWNSTREAM OF ROADWAY CENTERLINE

Example 2

The culvert is to be 20 m long and is to accommodate the June Q60 flow of 0.098 m³/s. It is a round CMP culvert with a 2.4m diameter.

Note: There are no smelt in the watercourse.

The culvert will be installed between station 0+065 and 0+085.

The following survey information is available:

Station	Streambed Elevation (m)
0+000	84.855
0+015	84.790
0+028	84.820
0+040	84.780
0+053	84.805
0+065	84.745
0+085	84.630
0+090	84.600
0+095	84.550
0+099	84.580
0+130	84.520
0+155	84.545
0+185	84.505

Determine the watercourse slope and if baffles are needed

The culvert diameter is 2.4m, 3 times the culvert diameter plus 3.5m equals 10.7m. According to the survey information, the first downstream control riffle beyond 10.7m from the culvert is located at station 0+099 and the upstream control is located at station 0+065.

The watercourse slope between the two stations is

$$((84.745-84.580)/34)*100 = 0.49\%$$

Therefore, **baffles are not needed.**

Fish Passage Design

Step 1: Determine the culvert outlet and inlet invert elevations

As determined above, the first downstream control riffle beyond 10.7 m from the culvert is at station 0+099 and the elevation is 84.580 m.

The downstream culvert outlet invert elevation at station 0+085 is to be set 0.2 times the culvert diameter (400 mm max.) below the elevation of the downstream control riffle at station 0+099 and will be:

$$0.2 \times 2.4 \text{ m} = 0.48 \text{ m} > 0.4 \text{ m}$$

$$84.580 \text{ m} - (0.4 \text{ m}) = 84.180 \text{ m}$$

The upstream culvert inlet invert elevation at station 0+065 is 84.745 m.

Step 2: Determine the dimensions of the energy dissipation pool

The width of the pool will be two times the diameter of the culvert:

$$2D = 4.8 \text{ m}$$

The length of the pool will be three times the diameter of the culvert plus a minimum of 3.5 m:

$$3D + 3.5 \text{ m} = 10.7 \text{ m}$$

Pool depth will be at least 1 m.

The pool outlet invert will be at elevation 84.580 m

Steps 3 and 4 are not required.

See the drawing on the following page.

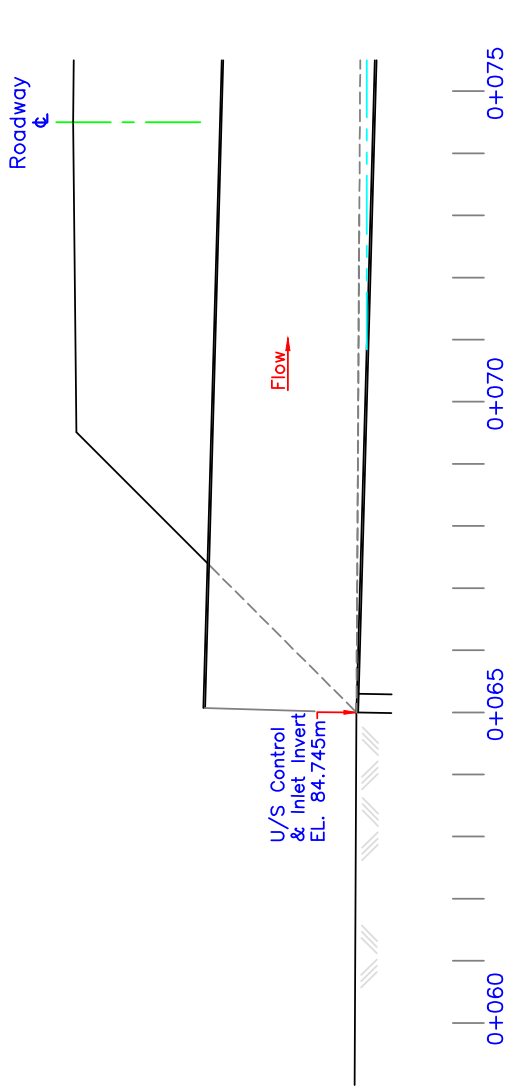

CULVERT PROFILE SECTION UPSTREAM OF ROADWAY CENTERLINE

NOTE

1. All dimensions are in millimeters unless otherwise noted.

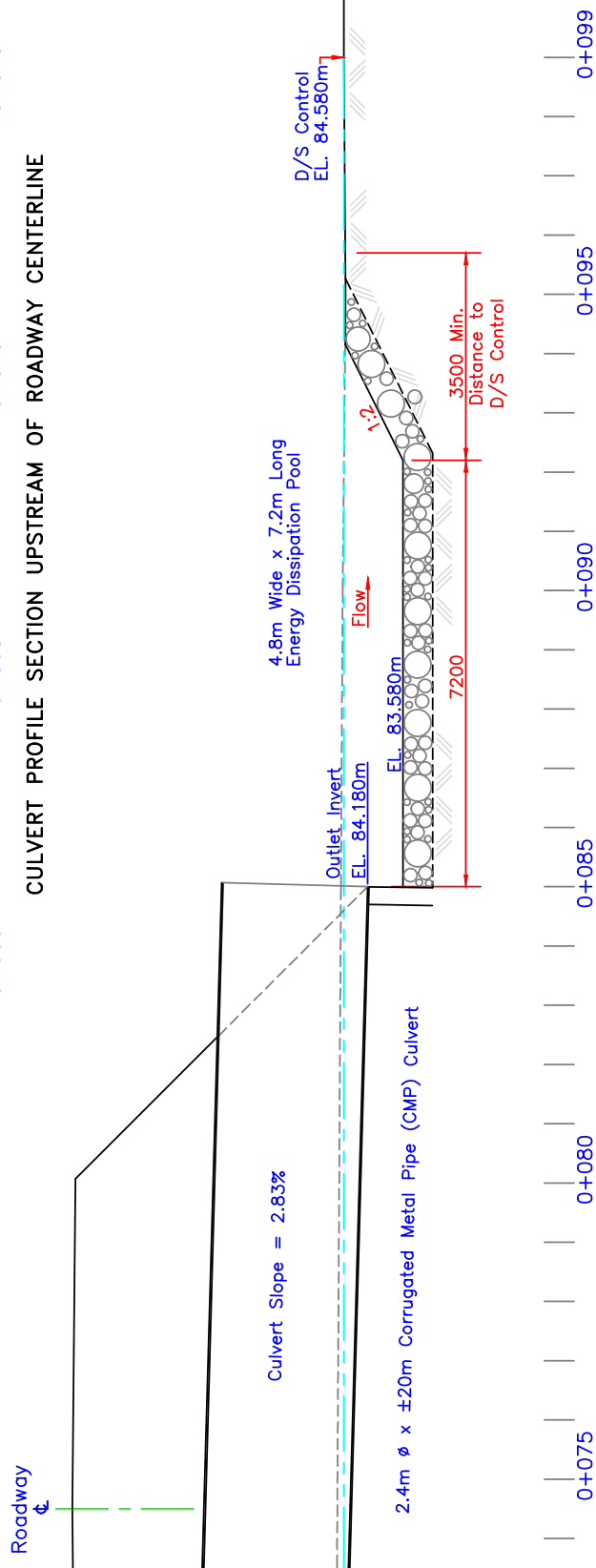

CULVERT PROFILE SECTION DOWNSTREAM OF ROADWAY CENTERLINE

Example 3

The culvert is to be 95 m long and is to accommodate the June Q60 flow of 0.118 m³/s. It is a 3 m wide x 2.4 m high concrete box culvert, each pre-fabricated section is 2.44 m long.

Note: There is no need to provide passage for smelt.

The lowest baffle will be at 0.4 m from the end of the culvert. The culvert will be installed between station 0+60 and 0+155.

The following survey information is available:

Station	Streambed Elevation (m)
0+000	100.590
0+014	100.315
0+027	100.325
0+041	100.103
0+055	100.150
0+060	99.902
0+155	98.275
0+159	98.122
0+170	98.145
0+212	97.430
0+255	97.500

Determine the watercourse slope and if baffles are needed

The box culvert width is 3 m, 3 times the box culvert width plus 3.5 m equals 12.5 m. According to the survey information, the first downstream control riffle beyond 12.5 m from the culvert is located at station 0+170 and the upstream control is located at station 0+060.

The watercourse slope between the two stations is

$$((99.902-98.145)/110)*100 = 1.60\%$$

Therefore, **baffles are needed.**

Fish Passage Design

Step 1: Determine the inlet and outlet invert elevations

Verify the lowest baffle location from the end of the culvert outlet.
 $0.4\text{m} < 1.25\text{m}$ OK

As determined above the first downstream control riffle beyond 12.5 m from the culvert is at station 0+170 and the elevation is 98.145 m.

The baffle top of the lowest baffle will also be at elevation 98.145 m. The invert of the culvert under this baffle will be:

$$98.145\text{ m} - 0.5\text{ m (baffle depth)} = 97.645\text{ m}$$

The upstream culvert inlet invert elevation at station 0+060 is 99.902 m

The slope of the culvert will be:
 $((99.902 - 97.645) / 95 - 0.4) * 100 = 2.39\%$

The downstream culvert outlet invert elevation at station 0+155 will be:
 $97.645 - (2.39\% * 0.4\text{ m}) = 97.635\text{ m}$

Step 2: Determine the dimensions of the energy dissipation pool

The width of the pool will be two times the width of the culvert:
 $2D = 6\text{ m}$

The length of the pool will be three times the width of the culvert plus a minimum of 3.5 m:
 $3D + 3.5\text{ m} = 12.5\text{ m}$

The pool depth will be at least 1 m.

The pool outlet invert will be at elevation 98.145 m

Step 3: Determine the baffles notch size

With a June Q60 flow of 0.118 m³/s, we look at Table 2 and determine that the following dimensions are needed:

Notch width.....500 mm
Notch depth.....250 mm
Baffle height.....500 mm

Step 4: Determine the baffle spacing

Maximum possible baffle spacing:

$$I = \Delta h / \text{culvert slope}$$

$$I = 0.200\text{m} / 2.39\% = 8.368\text{m}$$

In order to simplify the manufacturer’s task and the installation in the field, we will install the baffles at every 7.32m (every third section of 2.44m long pre-fabricated concrete box culvert). The difference of elevation between each baffle will now be 0.175m.

The baffles will be located as follows. See also the drawing on the following page.

Baffle #	Station	Notch Sill Elevation (m)
1	0+154.60	97.895
2	0+147.28	98.070
3	0+139.96	98.245
4	0+132.64	98.420
5	0+125.32	98.595
6	0+118.00	98.770
7	0+110.68	98.945
8	0+103.36	99.120
9	0+096.04	99.295
10	0+088.72	99.470
11	0+081.40	99.645
12	0+074.08	99.820
13	0+066.76	99.995

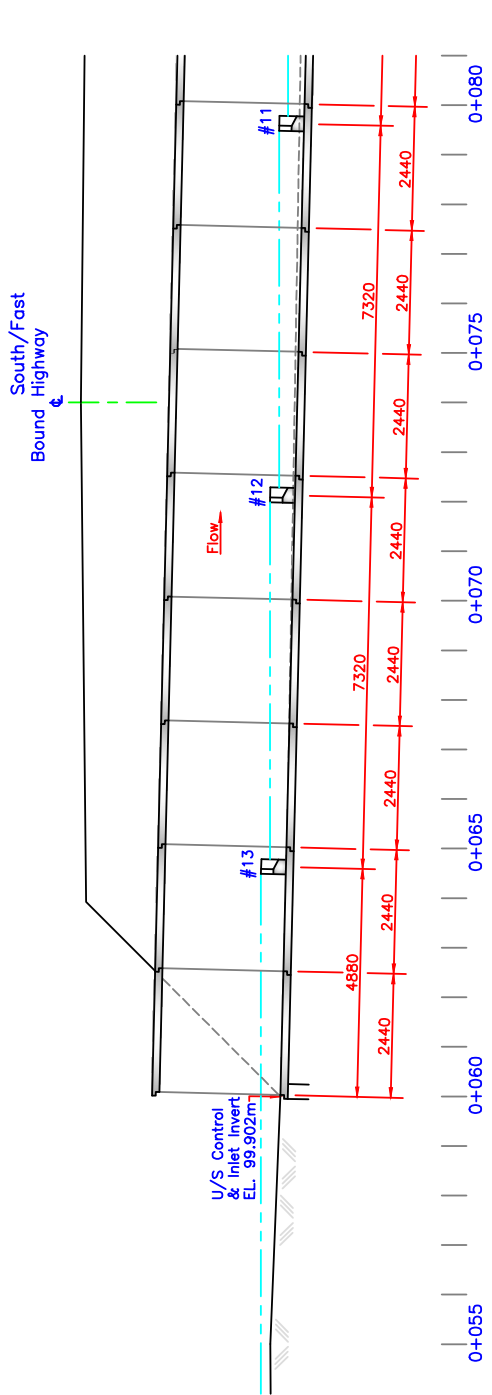

NOTE
 1. All dimensions are in millimeters unless otherwise noted.

CULVERT PROFILE SECTION UPSTREAM OF HIGHWAY CENTERLINE

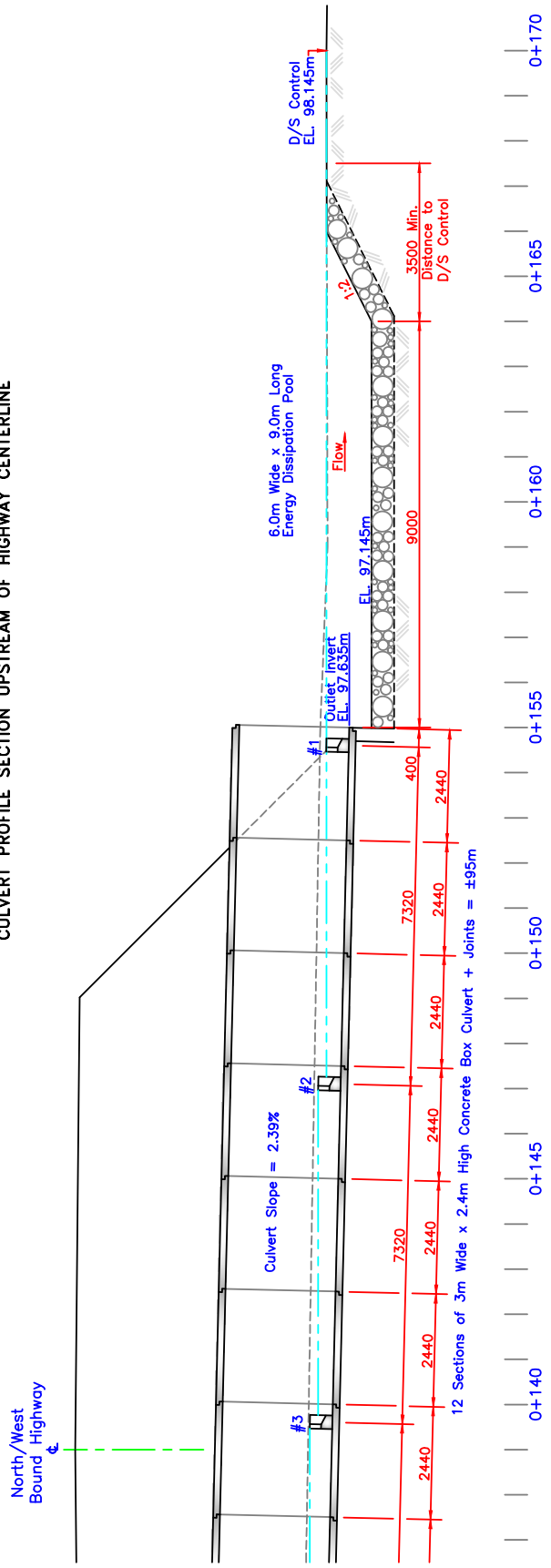

CULVERT PROFILE SECTION DOWNSTREAM OF HIGHWAY CENTERLINE

Example 4

The culvert is to be 10m long and is to accommodate the June Q60 flow of 0.025 m³/s. It is a round CMP culvert with a 1.2 m diameter.

Note: There is smelt in the watercourse.

The lowest baffle will be 1 m from the end of the culvert. The culvert will be installed between station 0+05 and 0+05.

The following survey information is available:

Station	Streambed Elevation (m)
0-35	12.700
0-08	12.300
0-06	12.400
0-05	12.250
0+00	11.800
0+05	12.200
0+10	11.800
0+12.1	12.000
0+35	11.700

Determine the watercourse slope and if baffles are needed

The culvert diameter is 1.2 m, 3 times the culvert diameter plus 3.5 m equals 7.1 m.

According to the survey information, the first downstream control riffle beyond 8 m from the culvert is located at station 0+12.1 and the proposed inlet invert and upstream control of the culvert is located at station 0-05.

The watercourse slope between the two stations is

$$((12.250-12.000)/7.1)*100 = 1.46\%$$

Therefore, **baffles are needed.**

Fish Passage Design

Step 1: Determine the culvert inlet and outlet invert elevations

Verify the lowest baffle location from the end of the culvert outlet.
 $1.00 \text{ m} < 1.25 \text{ m}$ OK

As determined above the first downstream control riffle beyond 7.1 m from the culvert is at station 0+12.1 and the elevation is 12.000 m.

The baffle top of the lowest baffle will also be at elevation 12.000 m. The invert of the culvert under this baffle will be:
 $12.000\text{m} - 0.5 \text{ m (baffle depth)} = 11.500 \text{ m}$

The upstream culvert inlet invert elevation at station 0-05 is

12.250 m The slope of the culvert will be:
 $((12.250 - 11.500) / 10 - 1.00) * 100 = 8.33\%$

The downstream culvert outlet invert elevation at station 0+05 will be: $11.500 - (8.33\% * 1.00 \text{ m}) = 11.417 \text{ m}$

Step 2: Determine the dimensions of the energy dissipation pool

The width of the pool will be two times the diameter of the culvert: $2D = 2.4 \text{ m}$

The length of the pool will be three times the diameter of the culvert plus a minimum of 3.5 m:
 $3D + 3.5 \text{ m} = 7.1 \text{ m}$

The pool depth will be at least 1 m.

The pool outlet invert will be at elevation 12.000 m

Step 3: Determine the baffles notch size

With a June Q60 flow of $0.025 \text{ m}^3/\text{s}$, we look at Table 2 and determine that the following dimensions are needed:

Notch
width.....150
mm Notch
depth.....200
mm Baffle
height.....500 mm

Step 4: Determine the baffle spacing

Maximum possible baffle
spacing $I = \Delta h / \text{culvert}$
slope

$$I = 0.150 \text{ m} / 8.33\% = 1.800 \text{ m}$$

Baffles will be installed at every 1.80 m. The difference of elevation between each baffle will be 0.150 m.

The baffles will be located as follows. See also the drawing on the following page.

Baffle #	Station	Notch Sill Elevation (m)
1	0+04	89.993
2	0+02.2	90.108
3	0+00.4	90.223
4	0-01.4	90.338
5	0-03.2	90.453

NOTE

1. All dimensions are in millimeters unless otherwise noted.

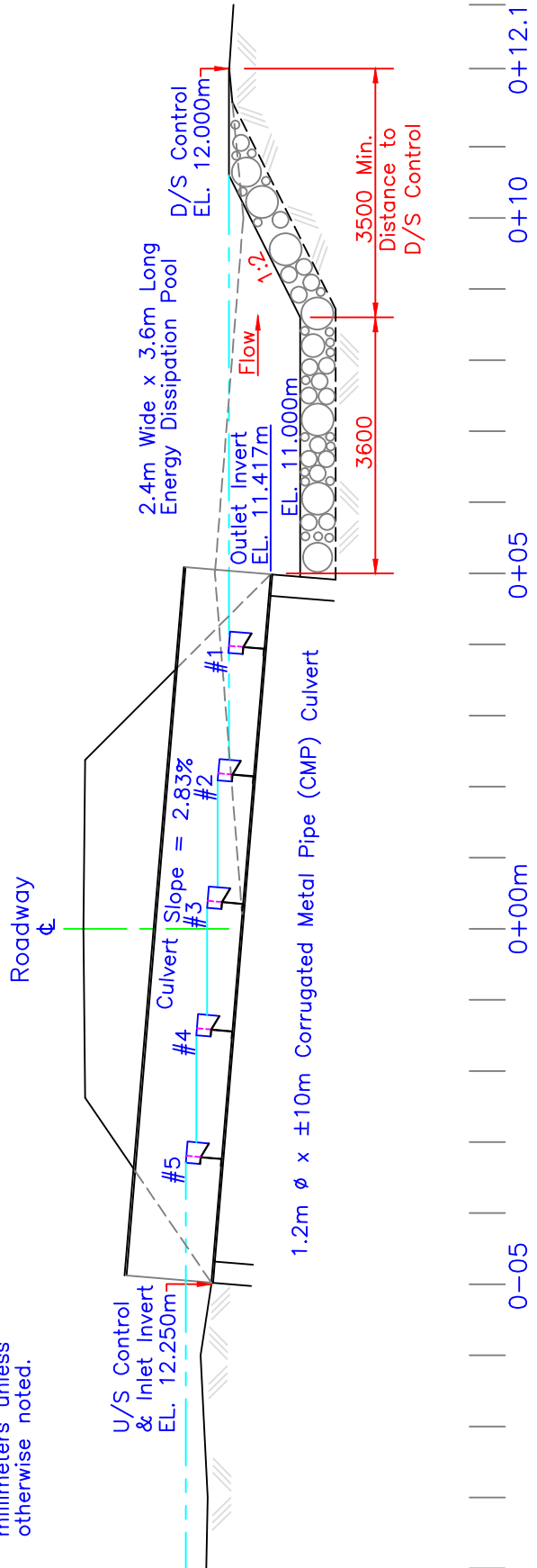

CULVERT PROFILE SECTION THROUGH ROADWAY

APPENDIX I: EXAMPLES OF TYPICAL BAFFLE PLACEMENT

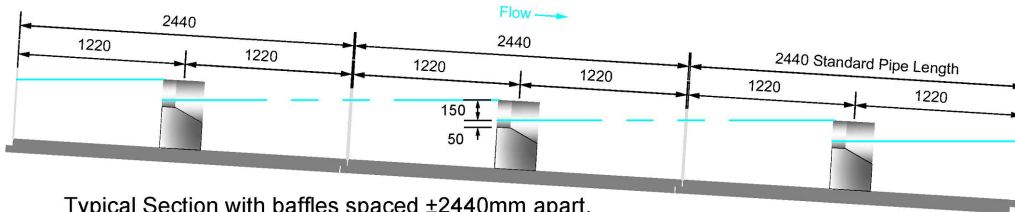

Typical Section with baffles spaced $\pm 2440\text{mm}$ apart, notches 200mm deep and with 150mm drops between pools = 6.15% max. culvert slope

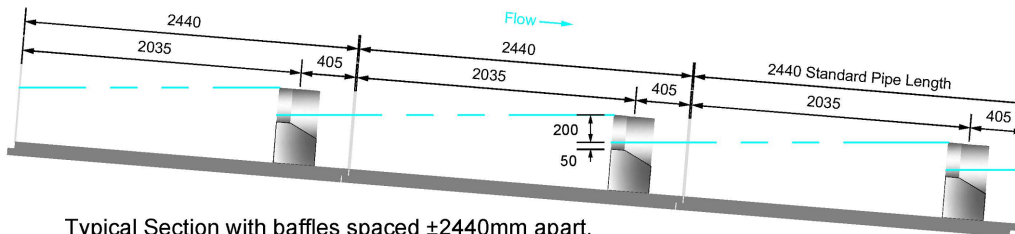

Typical Section with baffles spaced $\pm 2440\text{mm}$ apart, notches 250mm deep and with 200mm drops between pools = 8.20% max. culvert slope

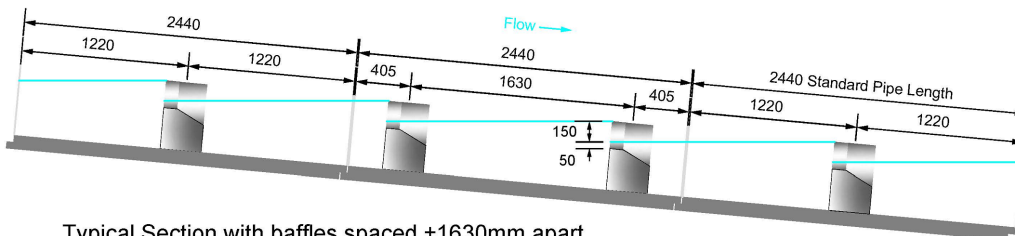

Typical Section with baffles spaced $\pm 1630\text{mm}$ apart, notches 200mm deep and with 150mm drops between pools = 9.15% max. culvert slope

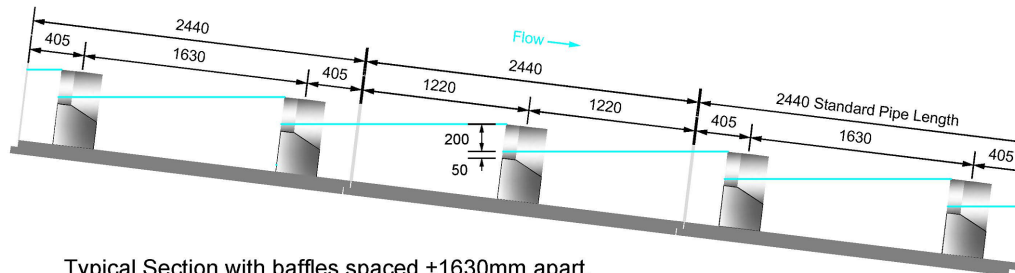

Typical Section with baffles spaced $\pm 1630\text{mm}$ apart, notches 250mm deep and with 200mm drops between pools = 12.20% max. culvert slope (note: 8% max. watercourse slope)

EXAMPLES OF TYPICAL BAFFLE PLACEMENT INSIDE 2.44m LENGTHS OF PRECAST CONCRETE PIPE

APPENDIX J: EXAMPLES OF TYPICAL FISH PASSAGE CHUTES FOR ROUND CULVERTS

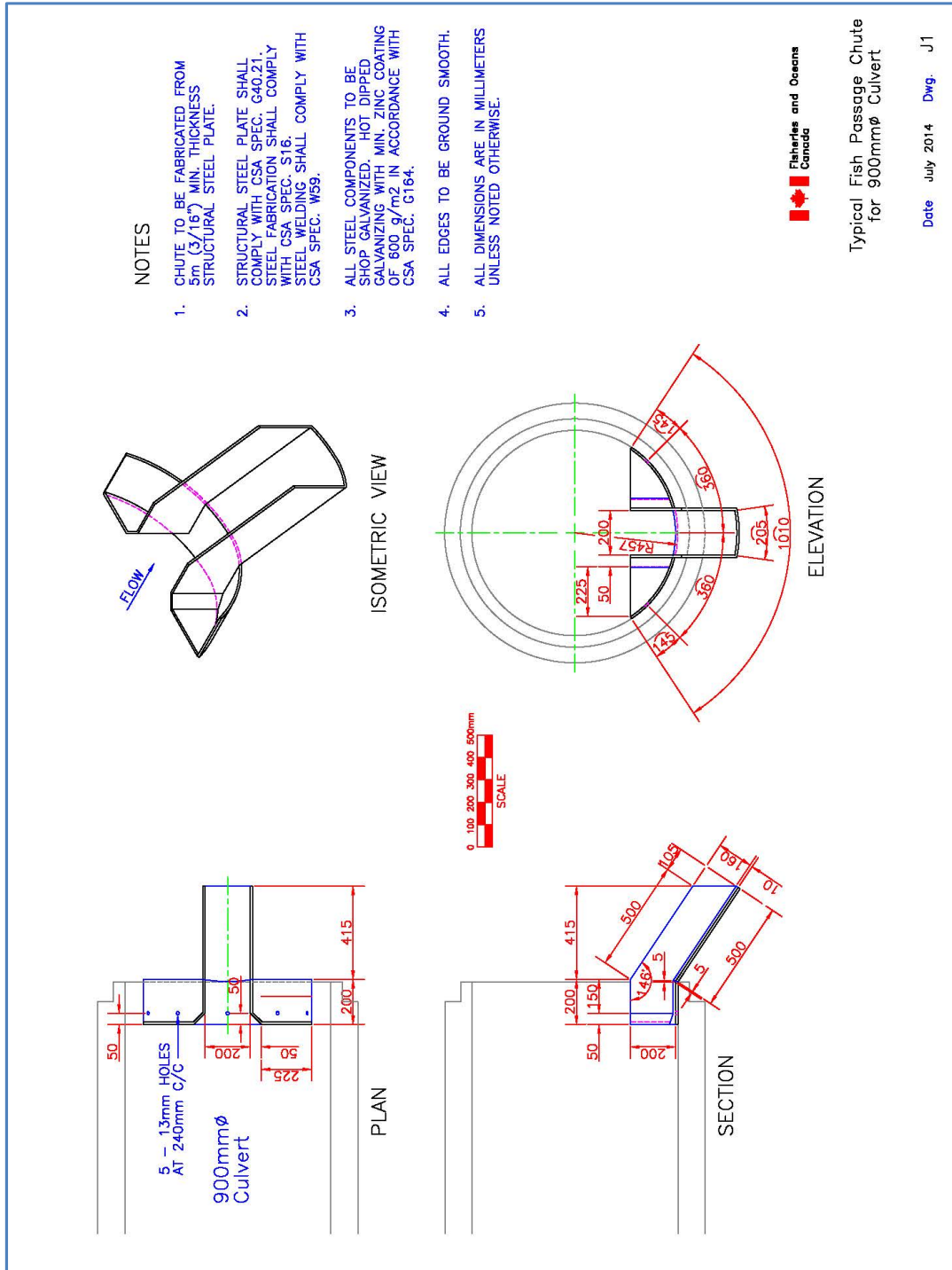

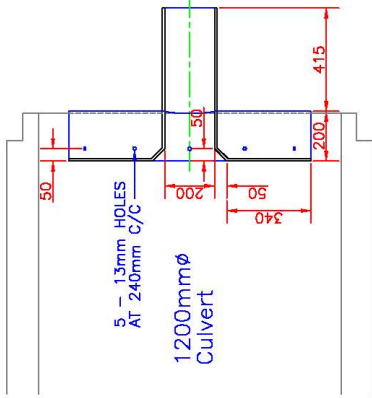

PLAN

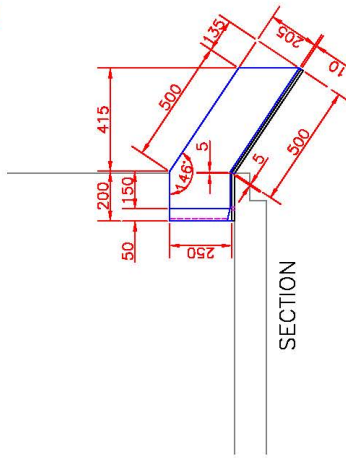

SECTION

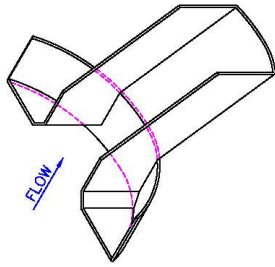

ISOMETRIC VIEW

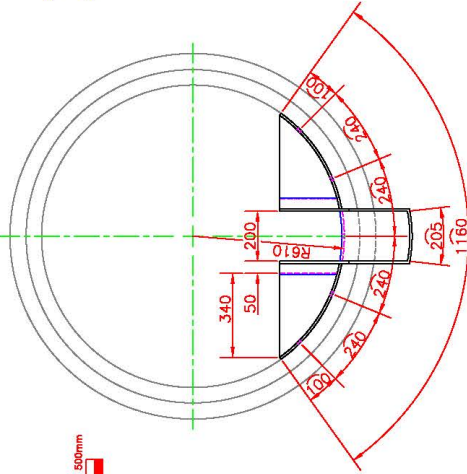

ELEVATION



Typical Fish Passage Chute
for 1200mm ϕ Culvert

Date July 2014 Dwg. JZ

NOTES

1. CHUTE TO BE FABRICATED FROM 5mm (3/16") MIN. THICKNESS STRUCTURAL STEEL PLATE.
2. STRUCTURAL STEEL PLATE SHALL COMPLY WITH CSA SPEC. G40.21. STEEL FABRICATION SHALL COMPLY WITH CSA SPEC. S16. STEEL WELDING SHALL COMPLY WITH CSA SPEC. W59.
3. ALL STEEL COMPONENTS TO BE SHOP GALVANIZED, HOT DIPPED GALVANIZING WITH MIN. ZINC COATING OF 600 g/m² IN ACCORDANCE WITH CSA SPEC. G164.
4. ALL EDGES TO BE GROUND SMOOTH.
5. ALL DIMENSIONS ARE IN MILLIMETERS UNLESS NOTED OTHERWISE.

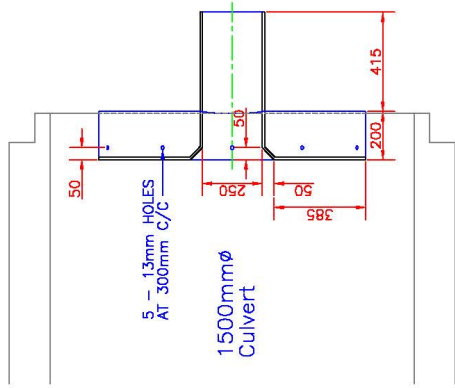

PLAN

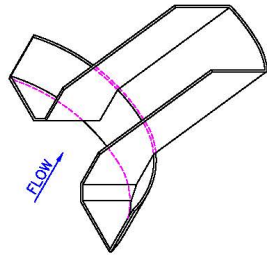

NOTES

1. CHUTE TO BE FABRICATED FROM 5mm (3/16") MIN. THICKNESS STRUCTURAL STEEL PLATE.
2. STRUCTURAL STEEL PLATE SHALL COMPLY WITH CSA SPEC. G40.21. STEEL FABRICATION SHALL COMPLY WITH CSA SPEC. S16. STEEL WELDING SHALL COMPLY WITH CSA SPEC. W59.
3. ALL STEEL COMPONENTS TO BE SHOP GALVANIZED. HOT DIPPED GALVANIZING WITH MIN. ZINC COATING OF 600 g/m² IN ACCORDANCE WITH CSA SPEC. G164.
4. ALL EDGES TO BE GROUND SMOOTH.
5. ALL DIMENSIONS ARE IN MILLIMETERS UNLESS NOTED OTHERWISE.

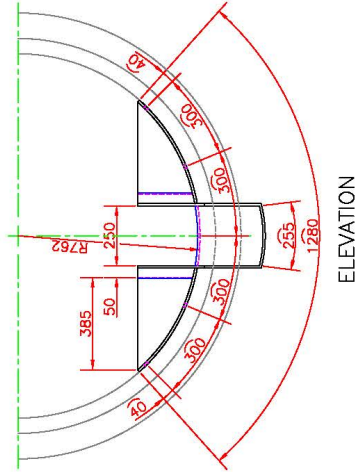
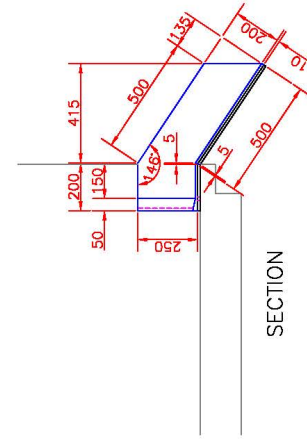

Typical Fish Passage Chute
for 1500mm ϕ Culvert

Date July 2014 Dwg. J3

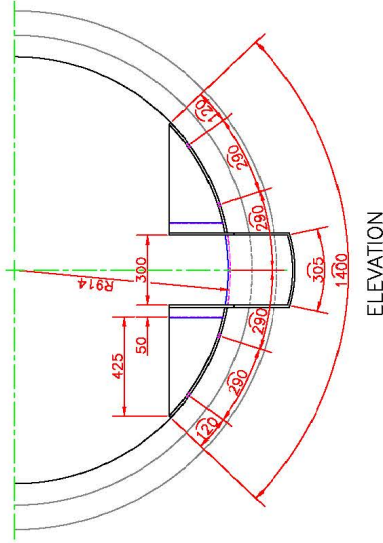
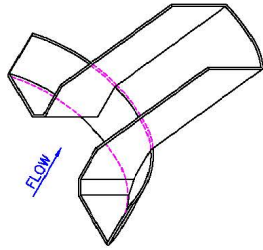
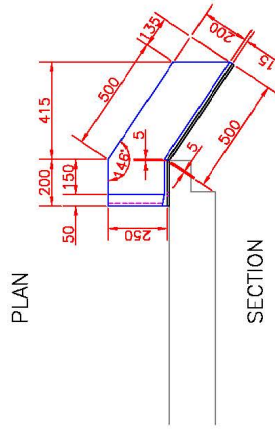
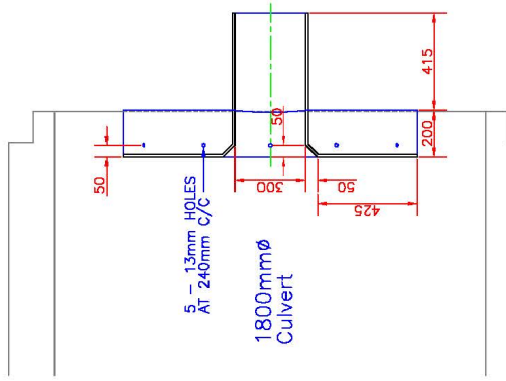

NOTES

1. CHUTE TO BE FABRICATED FROM 5mm (3/16") MIN. THICKNESS STRUCTURAL STEEL PLATE.
2. STRUCTURAL STEEL PLATE SHALL COMPLY WITH CSA SPEC. G40.21. STEEL FABRICATION SHALL COMPLY WITH CSA SPEC. S16. STEEL WELDING SHALL COMPLY WITH CSA SPEC. W59.
3. ALL STEEL COMPONENTS TO BE SHOP GALVANIZED, HOT DIPPED GALVANIZING WITH MIN. ZINC COATING OF 600 g/m² IN ACCORDANCE WITH CSA SPEC. G164.
4. ALL EDGES TO BE GROUND SMOOTH.
5. ALL DIMENSIONS ARE IN MILLIMETERS UNLESS NOTED OTHERWISE.



Typical Fish Passage Chute
for 1800mm ϕ Culvert

Date July 2014 Dwg. J4

